



HEAVY MECHANICAL COMPLEX LIMITED
Government Of Pakistan



TENDER ENQUIRY FOR RRC YEAR 2025-26.

NO. RRC/MW-26-002	Date: 15-06-2026	Due on: 01-07-2026
M/s _____ _____ _____		This schedule duly filled in & signed, may also be returned with your offer.

We invite you to submit your sealed quotation for the supply of following stores on Free Delivery HMC (FFW) basis. Please ensure that your quotation must reach the Head (SCM) by 1400hours for opening in public at 1430hours on due date.

S. NO.	DESCRIPTION	QUANTITY	UNIT	RATE (RS.)
1	Welding Electrode			
2	Electrode SS-E308, 2.6mm	500	Kgs	
3	Electrode SS-E308, 3.25mm	1000	Kgs	
4	Electrode SS-E308, 4mm	1000	Kgs	
5	Electrode SS-E309, 2.6mm	500	Kgs	
6	Electrode SS-E 309, 3.2mm	500	Kgs	
7	Electrode SS-E309, 4mm	1000	Kgs	
8	Electrode SS-E316, 2.6mm	500	Kgs	
9	Electrode SS-E316, 3.2mm	1000	Kgs	
9	Electrode SS-E316, 4mm	1000	Kgs	
<p>Tender Fee Rs. 1500/- on the name of MD-HMC in form of CDR must be attached alongwith offer. Bid Security@ 2%</p> <p>Note: Electrodes are to be Vaccume Packed. Original Brochure copy of third party approval certificate of electrodes manufacturing to be provided. One sealed pack of each electrode (Dia 4mm,05kg) and MTC must be provided with quotation. Supply and sample should comply with AWS-AS.1 or ASME Sec-II, Part-C, SFA.1</p> <p>- For HMC, Electrodes are to be delivered in Pallets of 01 Ton. - Procurement will be made on as and when required basis during the contract period from 1st July 2026 to 30th June 2027. - GST will be paid as per Government Rules.</p>				

F Head (Supply Chain Management)
Heavy Mechanical Complex Taxila.

Signature _____
Name _____
Firm's Name _____
Address _____

Tele No. _____
Fax No. _____

Declaration:

I / We certify that I / We have read all the terms and conditions (1-25) of the Tender Enquiry overleaf and the same are fully acceptable to me / us. Following documents are enclosed :

- a. Bid Money: _____
- b. Sales Tax Registration Certificate / No. _____
- c. National Tax No. _____

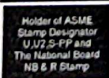

Taxila : 47050 Pakistan Phones : (+92-51) 9270562 (5 Lines), (+92-51) 9314181
Fax: (+92-51) 9270560, (92-51) 9314202, 3
Email: hmcengg@hmc.com.pk, marketing@hmc.com.pk & procurement.hmc@gmail.com
Web Site: http:// www.hmc.com.pk





HEAVY MECHANICAL COMPLEX LIMITED

Government Of Pakistan



TENDER ENQUIRY FOR RRC YEAR 2025-26.

UN/TE/03

No.	RRC/MW-26-003	Date:	15-06-2026	Due on:	01-07-2026
M/s	_____				
					This schedule duty filled in & signed, may also be returned with your offer.

We invite you to submit your sealed quotation for the supply of following stores on Free Delivery HMC (FFW) basis. Please ensure that your quotation must reach the Head (SCM) by 1400hours for opening in public at 1430hours on due date.

S. NO.	DESCRIPTION	QUANTITY	UNIT	RATE (RS.)
Welding Electrode				
1	Electrode-E7018, 1.6mm	1000	Kgs	
2	Electrode-E7018, 2.6mm	5000	Kgs	
3	Electrode-E7018, 3.25mm	15000	Kgs	
4	Electrode-E7018, 4mm	30000	Kgs	
5	Electrode-E7018, 5mm	40000	Kgs	
6	Electrode-E6013, 2mm	1000	Kgs	
7	Electrode-E6013, 2.6mm	5000	Kgs	
8	Electrode-E6013, 3.25mm	5000	Kgs	
9	Electrode-E6013, 4mm	5000	Kgs	
10	Electrode-E6013, 5mm	5000	Kgs	
Tender Fee Rs. 1500/- on the name of MD-HMC in form of CDR must be attached alongwith offer.				
Bid Security@ 2%				
Note:				
- Electrodes are to be Vaccume Packed.				
- Original Brochure copy of third party approval certificate of electrodes manufacturing to be provided.				
- One sealed pack of each electrode (Dia 4mm,05kg) and MTC must be provided with quotation.				
- Supply and sample should comply with AWS-AS.1 or ASME Sec-II, Part-C, SFA.1				
- For HMC, Electrodes are to be delivered in Pallets of 01 Ton.				
- Procurement will be made on as and when required basis during the contract period from 1st July 2026 to 30th June 2027.				
- GST will be paid as per Government Rules.				



Head (Supply Chain Management)
Heavy Mechanical Complex Taxila.

Declaration:

I / We certify that I / We have read all the terms and conditions (1-25) of the Tender Enquiry overleaf and the same are fully acceptable to me / us.
Following documents are enclosed :

- a. Bid Money: _____
b. Sales Tax Registration Certificate / No. _____
c. National Tax No. _____

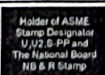
Signature _____
Name _____
Firm's Name _____
Address _____
Tele No. _____
Fax No. _____



Taxila : 47050 Pakistan Phones : (+92-51) 9270562 (5 Lines), (+92-51) 9314181
Fax: (+92-51) 9270560, (92-51) 9314202, 3
Email: hmcengg@hmc.com.pk, marketing@hmc.com.pk & procurement.hmc@gmail.com
Web Site: http:// www.hmc.com.pk



TENDER ENQUIRY

Case No.:	LPA-26-044A	Date:	16-Jun-26	Due on:	01-Jul-26
-----------	-------------	-------	-----------	---------	-----------

Please ensure to indicate your offer in this schedule. In case of shortage of space, you may use your letterhead but this schedule is to be returned duly filled in & signed.

The Tender must be accompanied by a non-refundable fee by means of a CDR/Demand Draft of Rs 1,500/-in favour of HMC, Taxila.

Sealed bids are invited on the basis of Free Delivery to HMC, Taxila for the supply of following items precisely according to the format depicted below. Bid must reach SCM Department by 1400 hours for opening in public at 1430 hours on due date.

Sr. NO.	DESCRIPTION	Unit	Qty.	Unit Price (Rs.)	Total (Rs.)
1	Four Jaws Chuck Ø350mm (China)	Nos	02		
2	Three Jaws Chuck Ø250mm (China)	Nos	02		

1. Sealed bids are invited on the basis of Free Delivery to HMC, Taxila
 2. Delivery Period should be max. upto 10 days.
 3. The offer validity should not be less than 30 days.
 4. Payment will be made after inspection & acceptance of stores at HMC Taxila.
 5. Quantity can be increased, decreased or deleted if necessary after tender opening.
 6. 2% Bid Security is essential to be submitted with quotation for total value of Rs. 500,000 /- or above.

Amount of GST shall be released against GST Invoice & Income Tax shall be deducted as per Govt. prevailing rules.

Offer No.: _____ Dated: _____

I upto: **DECLARATION**

Issued By :

We certify that we have read the terms and conditions of the tender enquiry over leaf and the same are fully acceptable to us. We further agree to provide performance bond, if required.



Head (SCM Department)
Heavy Mechanical Complex, Taxila.

Signature _____

Full Name _____

Seal of the Firm _____

Holder of ASME
Stamp Designator U.U2.S-PP
and
The National Board
NB & R Stamp

Taxila : 47060 Pakistan Phones : (+92-61) 9270562 (6 Lines), (+92-61) 9314181
 Fax: (+92-61) 9270660, (92-61) 9314202, 3
 Email: hmcengg@hmc.com.pk, marketing@hmc.com.pk & procurement.hmc@gmail.com
 Web Site: http://www.hmc.com.pk

TUV
AUSTRIA
HELLAS
CERTIFIED BY TUV
REGISTERED NO.
14160000000000



HEAVY MECHANICAL COMPLEX
Government Of Pakistan



PURTE/02

TENDER ENQUIRY

Case No.: LPA-26-044	Date: 16-Jun-26	Due on: 01-Jul-26
-----------------------------	------------------------	--------------------------

Please ensure to indicate your offer in this schedule. In case of shortage of space, you may use your letterhead but this schedule is to be returned duly filled in & signed.

The Tender must be accompanied by a non-refundable fee by means of a CDR/Demand Draft of Rs 1,500/- in favour of HMC, Taxila.

Sealed bids are invited on the basis of Free Delivery to HMC, Taxila for the supply of following items precisely according to the format depicted below. Bid must reach SCM Department by 1400 hours for opening in public at 1430 hours on due date.

Sr. NO.	DESCRIPTION	Unit	Qty.	Unit Price (Rs.)	Total (Rs.)
1	Threading Insert 161RAG60 (kyocera, Technocut)	Nos	20		
2	Internal Threading Tool SNR0025S16 (Length: 250 2525)	Nos	02		
3	Grub Screw 6 x 15mm	Nos	25		
4	Grub Screw 4 x 15mm	Nos	25		
5	HSS Twist Drill Ø25mm (Straight Shank)	Nos	05		
6	Carbide Drill Ø2.5mm (Straight Shank)	Nos	05		
7	Indexable Inserts DNMG 150604 (Sandvik, Kyocera, Technocut)	Nos	30		
8	Drill Chuck 1-16mm	Nos	03		

1. Sealed bids are invited on the basis of Free Delivery to HMC, Taxila
 2. Delivery Period should be max. upto 10 days.
 3. The offer validity should not be less than 30 days.
 4. Payment will be made after inspection & acceptance of stores at HMC Taxila.
 5. Quantity can be increased, decreased or deleted if necessary after tender opening.
 6. 2% Bid Security is essential to be submitted with quotation for total value of Rs. 500,000 /- or above.

Amount of GST shall be released against GST invoice & Income Tax shall be deducted as per Govt. prevailing rules.

Offer No.: _____ Dated: _____

Issued By :

Head (SCM Department)
Heavy Mechanical Complex, Taxila.

DECLARATION

We certify that we have read the terms and conditions of the tender enquiry over leaf and the same are fully acceptable to us. We further agree to provide performance bond, if required.

Signature _____

Full Name _____

Seal of the Firm _____

Holder of ASME
Stamp Designator U2.S-PP
and
The National Board
NB & R Stamp

Taxila : 47050 Pakistan Phones : (+92-61) 9270662 (5 Lines), (+92-61) 9314181
 Fax: (+92-61) 9270660, (92-61) 9314202, 3
 Email: hmcengg@hmc.com.pk, marketing@hmc.com.pk & procurement.hmc@gmail.com
 Web Site: http://www.hmc.com.pk



HMC**HEAVY MECHANICAL COMPLEX**
Government Of Pakistan**TENDER ENQUIRY**

PURTE/01

NO. PFH-26-027	Date: 12-06-26	Due on: 29-06-26
----------------	----------------	------------------

Please ensure to indicate your offer in this schedule. In case of shortage of space, you may use your letterhead but this schedule is to be returned duly filled in & signed.

Dear Sirs,

We invite your sealed bid on CFR basis for the supply of following store (s) as per format depicted below and over leaf. Bid must reach Admin Building by 1400 hours for opening in public at 1430 hours on due date.

S. NO.	DESCRIPTION	Qty.	Unit	Unit Price	Total Price
1	Rubber Seal as per Attached Sketch-1	300	Mtr		
2	D-Type Seal as per Attached Sketch-2	25	Mtr		

- Bidding Procedure: Single stage - Single Envelope
- Tender Fee: Rs. 1,500/-

Quotations submitted without the requisite 2% Bid Security and Tender Fee shall not be considered and will be rejected / returned on the spot.

Note: The following are mandatory and to be fulfilled.

- 1: Letter of Authorization as a local agent of Foreign principal must be attached with Quotation.
- 2: Quantity can be increased, decreased or deleted after tender opening if necessary.
- 3: Ocean freight charges upto Karachi seaport must be quoted Separately.
- 4: Offers having country of origin Israel & India will not be Considered.
- 5: Quotation of foreign principal must be attached.
- 6: 2% Bid security is essential to be submitted with Bid as per clause "2" of our Tender Enquiry Terms & Conditions.
- 7: Supplier can quote only one offer in a Tender, No Options / Alternate offers will be considered.
- 8: One Local Agent can quote offer only from one foreign principal in Tender. Local agent offering bids with more than one foreign principal will not be considered.
- 9: HMC may reject all those offers which have validity period less than required (30 days) against tender.
- 10: Supply reference record for the quoted material must be provided with the quotation.

Issued By :

For Head Purchase Department
Heavy Mechanical Complex Taxila.

Encl: Terms & Conditions, Proforma for Performance/Bid Bond

**DECLARATION**

We certify that we have read the terms and conditions of the tender enquiry over leaf and the same are fully acceptable to us. We further agree to provide performance bond, if required.

Signature _____

Full Name _____

Seal of the Firm _____

Taxila : 47050 Pakistan Phones : (+92-51) 9270562 (5 Lines), (+92-51) 9314181
Fax: (+92-51) 9270560, (92-51) 9314202, 3
Email: hmcengg@hmc.com.pk, marketing@hmc.com.pk & procurement.hmc@gmail.com
Web Site: http://www.hmc.com.pk



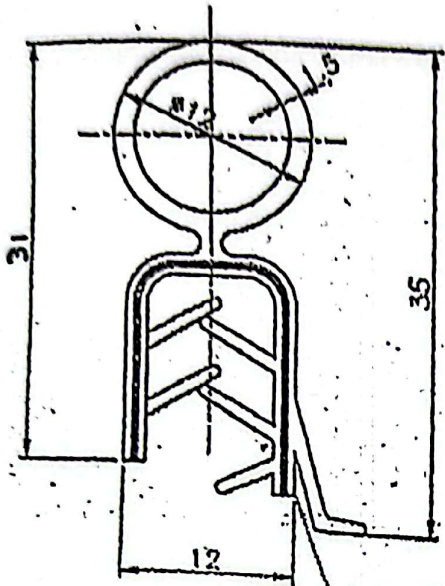

STEEL SPRING CORE

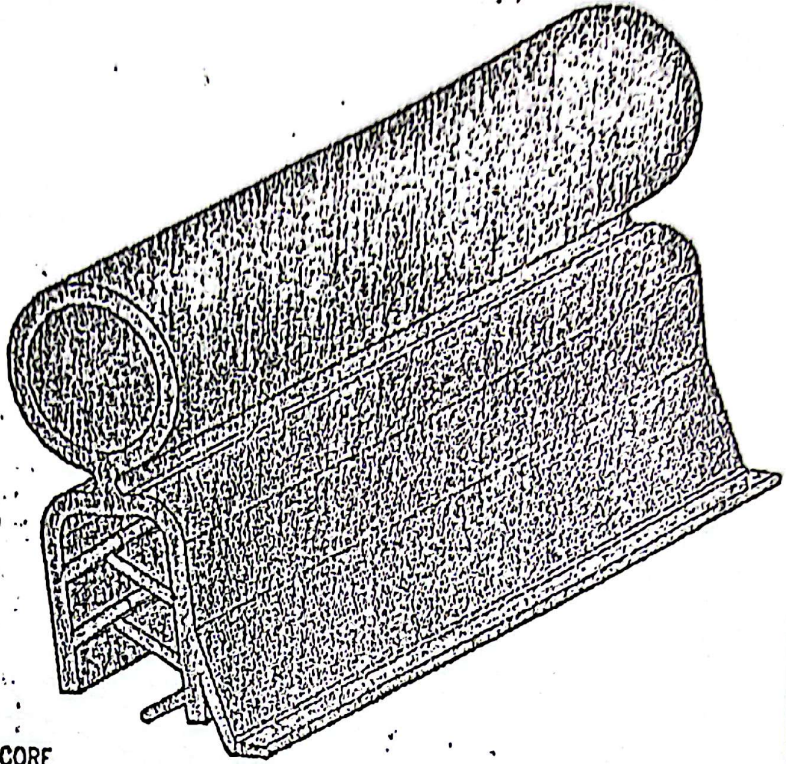

- SPONGE RUBBER EPDM (BLACK), HARDNESS 65 ± 5 DUROMETER SHORE TYPE A

Other Material

- OTHER SPECIFICATIONS OF EPDM SHALL BE AS FOLLOWS
- TENSILE STRENGTH: 3000 PSI (MIN.)
- ELONGATION AT BREAK: 450% (MIN.)

TITLE

SKETCH NO.

n/art

Sketch-2

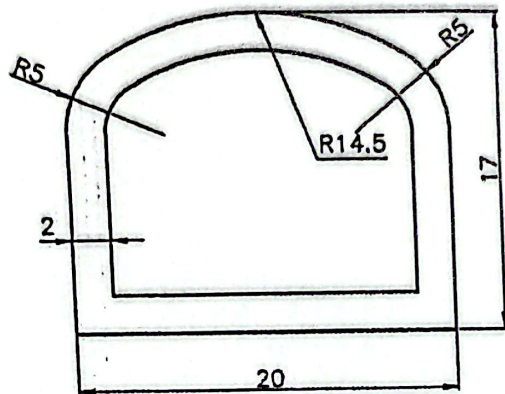

RUBBER SEAL

Srinivas
02-06-26



HEAVY MECHANICAL COMPLEX

Government Of Pakistan



PUR/TE/02

TENDER ENQUIRY

NO.	PLB-26-036	Date:	15-Jun-26	Due on :	01-Jul-26
-----	------------	-------	-----------	----------	-----------

Please ensure to indicate your offer in this schedule. In case of shortage of space, you may use your letterhead but this schedule is to be returned duly filled in & signed.

We invite your sealed bid on FOR/FOT Taxila or Free Delivery, HMC, Taxila basis for the supply of following store (s) precisely according to the format depicted below. Bid must reach Procurement Department by 1400 hours for opening in public at 1430 hours on due date.

S. NO.	DESCRIPTION	Unit.	Qty.	Unit Price (Rs.)	Delivery Period
1	Gasket OD 516 x ID 496 x 1.6 Thk (CNAF Compressed Non Asbestos Fiber)	Nos.	2		
2	Gasket OD 590 x ID 570 x 1.6 Thk (CNAF Compressed Non Asbestos Fiber)	Nos.	4		
3	Gasket OD 686 x ID 656 x 1.6 Thk (CNAF Compressed Non Asbestos Fiber)	Nos.	2		
4	Gasket OD 565 x ID 545 x 1.6 Thk (CNAF Compressed Non Asbestos Fiber)	Nos.	2		

Tender Fee: 1,500/- Non refundable

Note: 2% Bid security is essentially required for quotation of Rs. 500,000/- or above otherwise quotation will not be acceptable.

Important Note:

- The offer shall be quoted on FOR Taxila basis.
- Delivery Period should be minimum.
- Quantity can be increased, decreased or deleted after tender opening, if necessary.
- Validity: The offer validity should not be less than 30 days.
- Payment: Payment will be made after inspection & acceptance of stores at HMC Taxila.

NB: For Sales Tax and other Govt. levies please read clause 7 (e) of Terms and Conditions, overleaf.

Terms of Delivery : FOT/FOR Taxila - Free Delivery HMC Taxila.

Your offer No. & date : _____ Valid upto : _____

Additional Requirements : _____

Issued By : _____

DECLARATION

We certify that we have read the terms and conditions of the tender enquiry over leaf and the same are fully acceptable to us. We further agree to provide performance bond, if required.

Signature _____

Full Name _____

Seal of the Firm _____

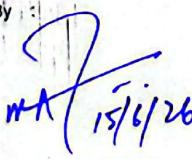
for  15/6/26

Head Procurement Department
Heavy Mechanical Complex, Taxila.



Taxila : 47050 Pakistan Phones : (+92-51) 9314262-5 (4 Lines), (+92-51) 9314181-5 (5 Lines)
Fax: (+92-51) 9270203, (92-51) 9314260
Email: hmcengg@hmc.com.pk, marketing@hmc.com.pk & procurement.hmc@gmail.com
Web Site: http:// www.hmc.com.pk





ENQUIRY

PLB-26-010	Date:	12-Jun-26	Due on :	29-Jun-26
------------	-------	-----------	----------	-----------

Please ensure to indicate your offer in this schedule. In case of shortage of space, you may use your letterhead but this schedule is to be returned duly filled in & signed.

Your sealed bid on FOR/FOT Taxila or Free Delivery, HMC, Taxila basis for the supply of following store(s) precisely to the format depicted below. Bid must reach Procurement Department by 1400 hours for opening in public at 1430 hours on due date.

DESCRIPTION	Unit.	Qty.	Unit Price (Rs.)	Delivery Period
G.I Flexible Conduits (PVC Coated) 2" Diameter	Mtrs.	900		
Pipe Gland For G.I Electrical Conduites 2" Diameter	Nos.	90		
Steel Clamps For Fixing of Conduites 2" Diameter	Nos.	1650		
Junction Box 600x600x200mm, Fabricated with MS sheet, powder coated with Bolted Door (Water Proof)	Nos.	12		
Wooden Screw 3"	Nos.	4000		
Rawal Plug	Nos.	4000		
Anchore Bolts (Half Inch Diameter)	Nos.	60		
PVC Pipes 4" Diameter	Mtrs.	200		

Tender Fee: 1,500/- Non refundable

Note: 2% Bid security is essentially required for quotation of Rs. 500,000/- or above otherwise quotation will not be acceptable.

Important Note:

- The offer shall be quoted on FOR Taxila basis.
- Delivery Period should be minimum.
- Quantity can be increased, decreased or deleted after tender opening, if necessary.
- Validity: The offer validity should not be less than 30 days.
- Payment: Payment will be made after inspection & acceptance of stores at HMC Taxila.

For Sales Tax and other Govt. levies please read clause 7 (e) of Terms and Conditions, overleaf.

Mode of Delivery : FOT/FOR Taxila - Free Delivery HMC Taxila. Valid upto : _____
 Offer No. & date : _____
 Additional Requirements : _____

Signed By : 
 12/6/26

Head Procurement Department
 Heavy Mechanical Complex, Taxila.

DECLARATION

We certify that we have read the terms and conditions of the tender enquiry over leaf and the same are fully acceptable to us. We further agree to provide performance bond, if required.

Signature _____

Full Name _____

Seal of the Firm _____

Holder of ASME
 Stamp Designator
 U2 S-PP and
 The National Board
 NB & R Stamp

Taxila : 47050 Pakistan Phones : (+92-51) 9314262-5 (4 Lines), (+92-51) 9314181-5 (5 Lines)
 Fax: (+92-51) 9270203, (92-51) 9314260
 Email: hmcengg@hmc.com.pk, marketing@hmc.com.pk & procurement.hmc@gmail.com
 Web Site: http:// www.hmc.com.pk





HEAVY MECHANICAL COMPLEX
Government Of Pakistan



PURTE/02

TENDER ENQUIRY

Case No.:	PLH-26-033	Date:	12-Jun-26	Due on:	29-Jun-26
-----------	------------	-------	-----------	---------	-----------

Blank space for bidder information.

Please ensure to indicate your offer in this schedule. In case of shortage of space, you may use your letterhead but this schedule is to be returned duly filled in & signed.

The Tender must be accompanied by a non-refundable fee by means of a CDR/Demand Draft of Rs 1,500/- in favour of HMC, Taxila.

Sealed bids are invited on the basis of Free Delivery to HMC, Taxila for the supply of following items precisely according to the format depicted below. Bid must reach SCM Department by 1400 hours for opening in public at 1430 hours on due date.

Sr. NO.	DESCRIPTION	Unit	Qty.	Unit Price (Rs.)	Total (Rs.)
1	Friction Disc (Brake Plates) Ø 580 x Ø 320 x 5mm	Nos	02		
2	Firection Disc (Brake Plates) Ø 400 x Ø 180 x 5mm	Nos	05		
3	Epoxy (Large Tubes)	Nos	07		
4	Spring, Wire Dia = 8mm, OD= 85mm, ID=69mm, No of Coiles= 06, Pitch=35mm, Length = 210mm	Nos	03		

1. Sealed bids are invited on the basis of Free Delivery to HMC, Taxila
 2. Delivery Period should be max. upto 10 days.
 3. The offer validity should not be less than 30 days.
 4. Payment will be made after inspection & acceptance of stores at HMC Taxila.
 5. Quantity can be increased, decreased or deleted if necessary after tender opening.
 6. **2% Bid Security is essential to be submitted with quotation for total quoted value of Rs. 500,000 /- or above.**

Amount of GST shall be released against GST invoice & Income Tax shall be deducted as per Govt. prevailing rules.

Offer No.: _____ Dated: _____

DECLARATION

Issued By :

for
12/6/26

Head (SCM Department)
Heavy Mechanical Complex, Taxila.

We certify that we have read the terms and conditions of the tender enquiry over leaf and the same are fully acceptable to us. We further agree to provide performance bond, if required.

Signature _____

Full Name _____

Seal of the Firm _____

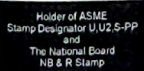

Taxila : 47050 Pakistan Phones : (+92-51) 9270562 (5 Lines), (+92-51) 9314181
 Fax: (+92-51) 9270560, (92-51) 9314202, 3
 Email: hmcengg@hmc.com.pk, marketing@hmc.com.pk & procurement.hmc@gmail.com
 Web Site: http:// www.hmc.com.pk





HEAVY MECHANICAL COMPLEX

Government Of Pakistan



TENDER ENQUIRY

NO.	PLH-26-037	Date:	15-Jun-26	Due on :	01-Jul-26
-----	------------	-------	-----------	----------	-----------

Please ensure to indicate your offer in this schedule. In case of shortage of space, you may use your letterhead but this schedule is to be returned duly filled in & signed.

We invite your sealed bid on FOR/FOT Taxila or Free Delivery, HMC, Taxila basis for the supply of following store (s) precisely according to the format depicted below. Bid must reach Procurement Department by 1400 hours for opening in public at 1430 hours on due date.

S. NO.	DESCRIPTION	Unit.	Qty.	Unit Price (Rs.)	Delivery Period
1	KVP-Engine Oil -Deo8000	Ltrs	50		
2	Engine Oil Delo Gold	Ltrs	150		
3	Grease	Kgs	250		
4	Hydraulic Oil HD 68	Ltrs	300		
5	C-Oil	Ltrs	300		
6	Mobile Oil 20W-50	Ltrs	500		

Tender Fee: 1,500/- Non refundable
 Note: 2% Bid security is essentially required for quotation of Rs. 500,000/- or above otherwise quotation will not be acceptable.

Important Note:

- The offer shall be quoted on FOR Taxila basis.
- Delivery Period should be minimum.
- Quantity can be increased, decreased or deleted after tender opening, if necessary.
- Validity: The offer validity should not be less than 30 days.
- Payment: Payment will be made after inspection & acceptance of stores at HMC Taxila.

NB: For Sales Tax and other Govt. levies please read clause 7 (e) of Terms and Conditions, overleaf.
 Terms of Delivery : FOT/FOR Taxila - Free Delivery HMC Taxila.

Your offer No. & date : _____ Valid upto : _____
 Additional Requirements : _____

DECLARATION

We certify that we have read the terms and conditions of the tender enquiry over leaf and the same are fully acceptable to us. We further agree to provide performance bond, if required.

Signature _____
 Full Name _____
 Seal of the Firm _____

Issued By : 
 15/6/26
 for
 Head Procurement Department
 Heavy Mechanical Complex, Taxila.



Taxila : 47050 Pakistan Phones : (+92-51) 9314262-5 (4 Lines), (+92-51) 9314181-5 (5 Lines)
 Fax: (+92-51) 9270203, (92-51) 9314260
 Email: hmcengg@hmc.com.pk, marketing@hmc.com.pk & procurement.hmc@gmail.com
 Web Site: http:// www.hmc.com.pk

