



HEAVY MECHANICAL COMPLEX
Government Of Pakistan



TENDER ENQUIRY

PUR/TE/01

NO.	PFH-26-025	Date:	08-06-26	Due on:	23-06-26
-----	------------	-------	----------	---------	----------

Please ensure to indicate your offer in this schedule. In case of shortage of space, you may use your letterhead but this schedule is to be returned duly filled in & signed.

Dear Sirs,

We invite your sealed bid on CFR basis for the supply of following store (s) as per format depicted below and over leaf. Bid must reach Admin Building by 1400 hours for opening in public at 1430 hours on due date.

S. NO.	DESCRIPTION	Qty.	Unit	Unit Price	Total Price
	<p>Two Way Air Hand Valve (HR-4, 1/2") Model: QGS x 230 AFA</p> <p>- Bidding Procedure: Single stage - Single Envelope - Tender Fee: Rs. 1,500/-</p> <p>Quotations submitted without the requisite 2% Bid Security and Tender Fee shall not be considered and will be rejected / returned on the spot.</p> <p>Note: The following are mandatory and to be fulfilled.</p> <p>1: Letter of Authorization as a local agent of Foreign principal must be attached with Quotation.</p> <p>2: Quantity can be increased, decreased or deleted after tender opening if necessary.</p> <p>3: Ocean freight charges upto Karachi seaport must be quoted Separately.</p> <p>4: Offers having country of origin Israel & India will not be Considered.</p> <p>5: Quotation of foreign principal must be attached.</p> <p>6: 2% Bid security is essential to be submitted with Bid as per clause "2" of our Tender Enquiry Terms & Conditions.</p> <p>7: Supplier can quote only one offer in a Tender, No Options / Alternate offers will be considered.</p> <p>8: One Local Agent can quote offer only from one foreign principal in Tender. Local agent offering bids with more than one foreign principal will not be considered.</p> <p>9: HMC may reject all those offers which have validity period less than required (30 days) against tender.</p> <p>10: Supply reference record for the quoted material must be provided with the quotation.</p>	16	Nos		

Issued By:

For Head Purchase Department
Heavy Mechanical Complex Taxila.

DECLARATION

We certify that we have read the terms and conditions of the tender enquiry over leaf and the same are fully acceptable to us. We further agree to provide performance bond, if required.

Signature _____

Full Name _____

Seal of the Firm _____

Encl: Terms & Conditions, Proforma for Performance/Bid Bond

Holder of ASME
Stamp Designator
U, U2, S-PP and
The National Board
NB & R Stamp.

Taxila : 47050 Pakistan Phones : (+92-51) 9270562 (5 Lines), (+92-51) 9314181
Fax: (+92-51) 9270560, (92-51) 9314202, 3
Email: hmcengg@hmc.com.pk, marketing@hmc.com.pk & procurement.hmc@gmail.com
Web Site: http:// www.hmc.com.pk





HEAVY MECHANICAL COMPLEX
Government Of Pakistan



TENDER ENQUIRY

PUR/TE/01

NO.	PFH-26-024	Date:	08-06-26	Due on:	23-06-26
-----	------------	-------	----------	---------	----------

Please ensure to indicate your offer in this schedule. In case of shortage of space, you may use your letterhead but this schedule is to be returned duly filled in & signed.

Dear Sirs,

We invite your sealed bid on CFR basis for the supply of following store (s) as per format depicted below and over leaf. Bid must reach Admin Building by 1400 hours for opening in public at 1430 hours on due date.

S. NO.	DESCRIPTION	Qty.	Unit	Unit Price	Total Price
	<p>Two Way Air Hand Valve (HR-4, 1/2") Model: QGS x 230 AFA</p> <p>- Bidding Procedure: Single stage - Single Envelope - Tender Fee: Rs. 1,500/-</p> <p>Quotations submitted without the requisite 2% Bid Security and Tender Fee shall not be considered and will be rejected / returned on the spot.</p> <p>Note: The following are mandatory and to be fulfilled.</p> <p>1: Letter of Authorization as a local agent of Foreign principal must be attached with Quotation.</p> <p>2: Quantity can be increased, decreased or deleted after tender opening if necessary.</p> <p>3: Ocean freight charges upto Karachi seaport must be quoted Separately.</p> <p>4: Offers having country of origin Israel & India will not be Considered.</p> <p>5: Quotation of foreign principal must be attached.</p> <p>6: 2% Bid security is essential to be submitted with Bid as per clause "2" of our Tender Enquiry Terms & Conditions.</p> <p>7: Supplier can quote only one offer in a Tender, No Options / Alternate offers will be considered.</p> <p>8: One Local Agent can quote offer only from one foreign principal in Tender. Local agent offering bids with more than one foreign principal will not be considered.</p> <p>9: HMC may reject all those offers which have validity period less than required (30 days) against tender.</p> <p>10: Supply reference record for the quoted material must be provided with the quotation.</p>	16	Nos		

Issued By

For Head Purchase Department
Heavy Mechanical Complex Taxila.

DECLARATION

We certify that we have read the terms and conditions of the tender enquiry over leaf and the same are fully acceptable to us. We further agree to provide performance bond, if required.

Signature _____

Full Name _____

Seal of the Firm _____

Encl: Terms & Conditions, Proforma for Performance/Bid Bond

Holder of ASME
Stamp Designator
U, U2, S-PP and
The National Board
NB & R Stamp.

Taxila : 47050 Pakistan Phones : (+92-51) 9270562 (5 Lines), (+92-51) 9314181
Fax: (+92-51) 9270560, (92-51) 9314202, 3
Email: hmcengg@hmc.com.pk, marketing@hmc.com.pk & procurement.hmc@gmail.com
Web Site: http:// www.hmc.com.pk





TENDER ENQUIRY

NO.	PFA-26-008	Date:	08-06-26	Due on:	23-06-26
-----	------------	-------	----------	---------	----------

Please ensure to indicate your offer in this schedule. In case of shortage of space, you may use your letterhead but this schedule is to be returned duly filled in & signed.

Dear Sirs,
We invite your sealed bid on CFR basis for the supply of following store (s) as per format depicted below and over leaf.
Bid must reach Admin Building by 1400 hours for opening in public at 1430 hours on due date.

S. NO.	DESCRIPTION	Qty.	Unit	Unit Price	Total Price
1	S/L Tube Dia 19.05x2.11x6000 = 572 Pcs	3432	Mtr		
2	Material:- ASTM A179/SA-179 (Seamless Tubes)				
3	General Requirement as per ASTM A450 / A450M				
4	Tube Should be Cold Drawn Seamless.				
5	Tube Should be Properly Straightened & free from defects. (Crack, Lap, Seam)				
6	Tube shall be hydrotested as per ASTM standard.				
7	Material Grade, Heat Number, Size, Manufacturer Name or Trade Mark should be clearly marked on each tube.				
8	MTC is req. as per EN 10204 - 3.1				
9	End Should be Plain cut / beveled.				
10	Proper Packing to avoid bending / damage during transportation.				
	- Bidding Procedure: Single stage - Single Envelope				
	- Tender Fee: Rs. 1,500/-				
	Quotations submitted without the requisite 2% Bid Security and Tender Fee shall not be considered and will be rejected / returned on the spot.				
	Note: The following are mandatory and to be fulfilled.				
	1: Letter of Authorization as a local agent of Foreign principal must be attached with Quotation.				
	2: Quantity can be increased, decreased or deleted after tender opening if necessary.				
	3: Ocean freight charges upto Karachi seaport must be quoted Separately.				
	4: Offers having country of origin Israel & India will not be Considered.				
	5: Quotation of foreign principal must be attached.				
	6: 2% Bid security is essential to be submitted with Bid as per clause "2" of our Tender Enquiry Terms & Conditions.				
	7: Supplier can quote only one offer in a Tender, No Options / Alternate offers will be considered.				
	8: One Local Agent can quote offer only from one foreign principal in Tender. Local agent offering bids with more than one foreign principal will not be considered.				
	9: HMC may reject all those offers which have validity period less than required (30 days) against tender.				
	10: Supply reference record for the quoted material must be provided with the quotation.				

Issued By : 
For Head Purchase Department
Heavy Mechanical Complex Taxila.

DECLARATION

We certify that we have read the terms and conditions of the tender enquiry over leaf and the same are fully acceptable to us. We further agree to provide performance bond, if required.

Signature _____
Full Name _____
Seal of the Firm _____

Encl: Terms & Conditions, Proforma for Performance/Bid Bond



Taxila : 47060 Pakistan Phones : (+92-51) 9270562 (5 Lines), (+92-51) 9314181
Fax: (+92-51) 9270560, (92-51) 9314202, 3
Email: hmcengg@hmc.com.pk, marketing@hmc.com.pk & procurement.hmc@gmail.com
Web Site: http:// www.hmc.com.pk



TENDER ENQUIRY

NO.	PLE-26-052	Date:	08-06-26	Due on :	23-06-26
-----	------------	-------	----------	----------	----------

M/s.	

schedule. In case of shortage of space, you may use your letterhead but this schedule is to be returned duly filled in & signed.

We invite your sealed bid on FOR / FOT Taxila or Free Delivery, HMC, Taxila basis for the supply of following store (s) precisely according to the format depicted below. Bid must reach office of Director (SCM) by 1400hours for opening in public at 1430hours on due date.

S. NO.	DESCRIPTION	Qty.	Unit	Unit Price (Rs.)	Delivery Period
	<p>S/L Tube Dia 19.05x2.11x6000 = 572 Pcs</p> <p>Material:- ASTM A179/SA-179 (Seamless Tubes) General Requirement as per ASTM A450 / A450M Tube Should be Cold Drawn Seamless. Tube Should be Properly Straightened & free from defects. (Crack, Lap, Seam) Tube shall be hydrotested as per ASTM standard. Material Grade, Heat Number, Size, Manufacturer Name or Trade Mark should be clearly marked on each tube. MTC is req. as per EN 10204 - 3.1 End Should be Plain cut / beveled. Proper Packing to avoid bending / damage during transportation.</p> <p>Quotations submitted without the requisite 2% Bid Security and Tender Fee shall not be considered and will be rejected / returned on the spot.</p> <p>- Tender Fee: Rs. 1,500/-</p> <p>Note:</p> <ol style="list-style-type: none"> The offer shall be quoted on FOR HMC Taxila basis. Delivery Period should be max. upto 10 days. Validity: The offer validity should not be less than 30-days. 	3,432	Mtr		

NB: For Sales Tax and other Govt. levies please read clause 7 (e) of Terms and Conditions, overleaf.

Terms of Delivery :FOR HMC Taxila

Your offer No. & date : _____ Valid upto : _____

Additional Requirements : _____

DECLARATION

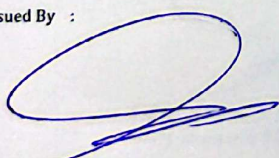
Issued By : 
 Director (SCM)
 Heavy Mechanical Complex Taxila.

We certify that we have read the terms and conditions of the tender enquiry over leaf and the same are fully acceptable to us. We further agree to provide performance bond, if required.

Signature _____

Full Name _____

Seal of the Firm _____



Taxila : 47050 Pakistan Phones : (+92-51) 9270562 (5 Lines), (+92-51) 9314181
 Fax: (+92-51) 9270560, (92-51) 9314202, 3
 Email: hmcengg@hmc.com.pk, marketing@hmc.com.pk & procurement.hmc@gmail.com
 Web Site: http:// www.hmc.com.pk



TENDER ENQUIRY

NO.	PFA-28-009	Date:	08-06-26	Due on:	23-06-26
-----	------------	-------	----------	---------	----------

Please ensure to indicate your offer in this schedule. In case of shortage of space, you may use your letterhead but this schedule is to be returned duly filled in & signed.

Dear Sirs,

We invite your sealed bid on CFR basis for the supply of following store (s) as per format depicted below and over leaf.
Bid must reach Admin Building by 1400 hours for opening in public at 1430 hours on due date.

S. NO.	DESCRIPTION	Qty.	Unit	Unit Price	Total Price
	<p>S/L Pipe, Material: SA-106 Gr.B</p> <p>Dia 22" (ID - 539.7 / OD 558.8, Thk. 9.52, L 5060 = 02 Pcs.)</p> <p>MTC is Required</p> <p>- Bidding Procedure: Single stage - Single Envelope - Tender Fee: Rs. 1,500/-</p> <p>Quotations submitted without the requisite 2% Bid Security and Tender Fee shall not be considered and will be rejected / returned on the spot.</p> <p>Note: The following are mandatory and to be fulfilled.</p> <ol style="list-style-type: none"> 1: Letter of Authorization as a local agent of Foreign principal must be attached with Quotation. 2: Quantity can be increased, decreased or deleted after tender opening if necessary. 3: Ocean freight charges upto Karachi seaport must be quoted Separately. 4: Offers having country of origin Israel & India will not be Considered. 5: Quotation of foreign principal must be attached. 6: 2% Bid security is essential to be submitted with Bid as per clause "2" of our Tender Enquiry Terms & Conditions. 7: Supplier can quote only one offer in a Tender, No Options / Alternate offers will be considered. 8: One Local Agent can quote offer only from one foreign principal in Tender. Local agent offering bids with more than one foreign principal will not be considered. 9: HMC may reject all those offers which have validity period less than required (30 days) against tender. 10: Supply reference record for the quoted material must be provided with the quotation. 	2	Pcs		

Issued By :



For Head Purchase Department
Heavy Mechanical Complex Taxila.

Encl: Terms & Conditions, Proforma for Performance/Bid Bond

DECLARATION

We certify that we have read the terms and conditions of the tender enquiry over leaf and the same are fully acceptable to us. We further agree to provide performance bond, if required.

Signature _____

Full Name _____

Seal of the Firm _____

Holder of ASME
Stamp Designator
U, U2, S-PP and
The National Board
NB & R Stamp.

Taxila : 47050 Pakistan Phones : (+92-51) 9270562 (5 Lines), (+92-51) 9314181
Fax: (+92-51) 9270560, (92-51) 9314202, 3
Email: hmcengg@hmc.com.pk, marketing@hmc.com.pk & procurement.hmc@gmail.com
Web Site: http:// www.hmc.com.pk

TUV
AUSTRIA
HELLAS

TENDER ENQUIRY

NO.	PLE-26-053	Date:	08-06-26	Due on:	23-06-26
-----	------------	-------	----------	---------	----------

M/s. _____

schedule. In case of shortage of space, you may use your letterhead but this schedule is to be returned duly filled in & signed.

We invite your sealed bid on FOR /FOT Taxila or Free Delivery, HMC, Taxila basis for the supply of following store (s) precisely according to the format depicted below. Bid must reach office of Director (SCM) by 1400hours for opening in public at 1430hours on due date.

S. NO.	DESCRIPTION	Qty.	Unit	Unit Price (Rs.)	Delivery Period
	<p>S/L Pipe, Material: SA-106 Gr.B Dia 22" (ID - 539.7 / OD 558.8, Thk. 9.52, L 5060 = 02 Pcs.)</p> <p>MTC is Required</p> <p>Quotations submitted without the requisite 2% Bid Security and Tender Fee shall not be considered and will be rejected / returned on the spot.</p> <p>- Tender Fee: Rs. 1,500/-</p> <p>Note: 1. The offer shall be quoted on FOR HMC Taxila basis. 2. Delivery Period should be max. upto 10 days. 3. Validity: The offer validity should not be less than 30-days.</p>	2	Pcs		

NB: For Sales Tax and other Govt. levies please read clause 7 (e) of Terms and Conditions, overleaf.

Terms of Delivery :FOR HMC Taxila

Your offer No. & date : _____ Valid upto : _____

Additional Requirements : _____

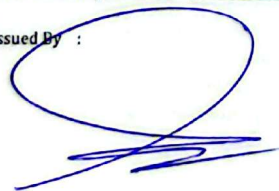
Issued By : 
 Director (SCM)
 Heavy Mechanical Complex Taxila.

DECLARATION

We certify that we have read the terms and conditions of the tender enquiry over leaf and the same are fully acceptable to us. We further agree to provide performance bond, if required.

Signature _____

Full Name _____

Seal of the Firm _____

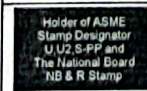

Taxila : 47050 Pakistan Phones : (+92-51) 9270562 (5 Lines), (+92-51) 9314101
 Fax: (+92-51) 9270560, (92-51) 9314202, 3
 Email: hmcengg@hmc.com.pk, marketing@hmc.com.pk & procurement.hmc@gmail.com
 Web Site: http:// www.hmc.com.pk





HEAVY MECHANICAL COMPLEX LIMITED
Government Of Pakistan



TENDER ENQUIRY FOR RRC YEAR 2026-27.

18/TE/03

NO. FFW/RRC-26-026	Date: 08-06-26	Due on : 18-06-26
M/s _____ _____ _____		This schedule duty filled in & signed, may also be returned with your offer.

We invite you to submit your sealed quotation for the supply of following stores on Free Delivery HMC (FFW) basis. Please ensure that your quotation must reach the Head (SCM) by 1400hours for opening in public at 1430hours on due date.

S. NO.	DESCRIPTION	QUANTITY	UNIT	RATE (RS.)
	<p>Sodium Silicate Specifications: SiO₂ = 32 - 36 % Na₂O = 13 - 15% Fe₂O₃ = 02% max. Sp. Gravity = 1.5 -1.6 g / cm³ at 20°C Density = 48 -52 Baume at 20°C Modulus = $\frac{SiO_2 \times 1.033}{Na_2O} = 2.2 - 2.5$</p> <p>Note:</p> <ul style="list-style-type: none"> - Procurement will be made on as and when required basis during the contract period from 1st July 2026 to 30th June 2027. - GST will be paid as per Government Rules. - Tender Fee Rs. 1500/- on the name of MD-HMC in form of CDR must be attached alongwith offer. - Bid Security @ 2% 	120	MT	

Feb
Head (Supply Chain Management)
Heavy Mechanical Complex Taxila.

Declaration:

I / We certify that I / We have read all the terms and conditions (1-25) of the Tender Enquiry overleaf and the same are fully acceptable to me / us.
Following documents are enclosed :

- a. Bid Money: _____
- b. Sales Tax Registration Certificate / No. _____
- c. National Tax No. _____

Signature _____
Name _____
Firm's Name _____
Address _____

Tele No. _____
Fax No. _____



Taxila : 47050 Pakistan Phones : (+92-51) 9270562 (5 Lines), (+92-51) 9314181
Fax: (+92-51) 9270560, (92-51) 9314202, 3
Email: hmcengg@hmc.com.pk, marketing@hmc.com.pk & procurement.hmc@gmail.com
Web Site: http:// www.hmc.com.pk





HEAVY MECHANICAL COMPLEX
Government Of Pakistan



PURTE/02

TENDER ENQUIRY

Case No.:	PLB-26-035	Date:	08-Jun-26	Due on:	23-06-26
-----------	-------------------	-------	------------------	---------	-----------------

Please ensure to indicate your offer in this schedule. In case of shortage of space, you may use your letterhead but this schedule is to be returned duly filled in & signed.

The Tender must be accompanied by a non-refundable fee by means of a CDR/Demand Draft of Rs 1,500/- in favour of HMC, Taxila.

Sealed bids are invited on the basis of Free Delivery to HMC, Taxila for the supply of following items precisely according to the format depicted below. Bid must reach SCM Department by 1400 hours for opening in public at 1430 hours on due date.

Sr. NO.	DESCRIPTION	Unit	Qty.	Unit Price (Rs.)	Total (Rs.)
1	Stud M 16 x 200 2 Nuts (ASTM-A-194 Gr. 2H, ASTM A-193 Gr. B7)	Nos	48		
2	Stud M 16 x 220 With 2 Nuts (ASTM-A-194 Gr. 2H, ASTM A-193 Gr. B7)	Nos	16		
3	Stud M 20 x 200 With 2 Nuts (ASTM-A-194 Gr. 2H, ASTM A-193 Gr. B7)	Nos	120		
4	Hex Nut M 12 (ASTM-A-194 Gr. 2H)	Nos	24		
5	Washer Dia 12 (Mat. MS)	Nos	12		
6	Washer Dia 16 (Mat. MS)	Nos	96		
7	Washer Dia 20 (Mat. MS)	Nos	240		
<p>MTC is Required</p> <ol style="list-style-type: none"> 1. Sealed bids are invited on the basis of Free Delivery to HMC, Taxila 2. Delivery Period should be max. upto 10 days. 3. The offer validity should not be less than 30 days. 4. Payment will be made after inspection & acceptance of stores at HMC Taxila. 5. Quantity can be increased, decreased or deleted if necessary after tender opening. 6. 2% Bid Security is essential to be submitted with quotation for total value of Rs. 500,000 /- or above. 					

Amount of GST shall be released against GST invoice & Income Tax shall be deducted as per Govt. prevailing rules.

Offer No.: _____ Dated: _____ I upto: _____

Issued By :
Head (SCM Department)
Heavy Mechanical Complex, Taxila.

DECLARATION

We certify that we have read the terms and conditions of the tender enquiry over leaf and the same are fully acceptable to us. We further agree to provide performance bond, if required.

Signature _____

Full Name _____

Seal of the Firm _____

Holder of ASME
Stamp Designator U2.S-PP
AND
The National Board
HB & R Stamp

Taxila : 47050 Pakistan Phones : (+92-51) 9270562 (5 Lines), (+92-51) 9314181
Fax: (+92-51) 9270560, (+92-51) 9314202, 3
Email: hmcengg@hmc.com.pk, marketing@hmc.com.pk & procurement hmc@gmail.com
Web Site: http://www.hmc.com.pk





HEAVY MECHANICAL COMPLEX LIMITED
Government Of Pakistan



P/R/TE/03

TENDER ENQUIRY FOR RRC YEAR 2026-27.

NO.	FFW/RRC-26-019	Date:	05-06-26	Due on:	18-06-26
M/s _____ _____ _____				This schedule duty filled in & signed, may also be returned with your offer.	

We invite you to submit your sealed quotation for the supply of following stores on **Free Delivery HMC (FFW)** basis. Please ensure that your quotation must reach the Head (SCM) by 1400hours for opening in public at 1430hours on due date.

S. NO.	DESCRIPTION	QUANTITY	UNIT	RATE (RS.)
	Magnesium Chloride (Crystalline MgCl₂ 6H₂O) Specifications: Density = 1.569 Kg/dm ³ Purity = 80% min Moisture content = 0.5% max Note: - Procurement will be made on as and when required basis during the contract period from 1st July 2026 to 30th June 2027. - GST will be paid as per Government Rules. - Tender Fee Rs. 1500/- on the name of MD-HMC in form of CDR must be attached alongwith offer.	10	MT	

For Head (Supply Chain Management)
 Heavy Mechanical Complex Taxila.

Declaration:

I / We certify that I / We have read all the terms and conditions (1-25) of the Tender Enquiry overleaf and the same are fully acceptable to me / us.
 Following documents are enclosed :

- a. Bid Money: _____
- b. Sales Tax Registration Certificate / No. _____
- c. National Tax No. _____

Signature _____

Name _____

Firm's Name _____

Address _____

Tele No. _____

Fax No. _____

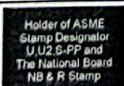

Taxila ; 47050 Pakistan Phones : (+92-51) 9270562 (5 Lines), (+92-51) 9314181
 Fax: (+92-51) 9270560, (92-51) 9314202, 3
 Email: hmcengg@hmc.com.pk, marketing@hmc.com.pk & procurement.hmc@gmail.com
 Web Site: http:// www.hmc.com.pk





HEAVY MECHANICAL COMPLEX LIMITED

Government Of Pakistan



TENDER ENQUIRY FOR RRC YEAR 2026-27.

PUR/TE/03

NO. MW/RRC-26-005	Date: 05-06-26	Due on: 18-06-26
M/s _____ _____ _____		This schedule duly filled in & signed, may also be returned with your offer.

We invite you to submit your sealed quotation for the supply of following stores on Free Delivery HMC (FFW) basis. Please ensure that your quotation must reach the Head (SCM) by 1400hours for opening in public at 1430hours on due date.

S. NO.	DESCRIPTION	QUANTITY	UNIT	RATE (RS.)
	Paint Red Oxide Primer	20,000	Ltr	
<p>Note:</p> <ul style="list-style-type: none"> - Procurement will be made on as and when required basis during the contract period from 1st July 2026 to 30th June 2027. - GST will be paid as per Government Rules. - Tender Fee Rs. 1500/- on the name of MD-HMC in form of CDR must be attached alongwith offer. 				

Head (Supply Chain Management)
Heavy Mechanical Complex Taxila.

Declaration:

I / We certify that I / We have read all the terms and conditions (1-25) of the Tender Enquiry overleaf and the same are fully acceptable to me / us. Following documents are enclosed :

- a. Bid Money: _____
- b. Sales Tax Registration Certificate / No. _____
- c. National Tax No. _____

Signature _____
 Name _____
 Firm's Name _____
 Address _____

 Tele No. _____
 Fax No. _____



Taxila : 47050 Pakistan Phones : (+92-51) 9270562 (5 Lines), (+92-51) 9314181
 Fax: (+92-51) 9270560, (92-51) 9314202, 3
 Email: hmcengg@hmc.com.pk, marketing@hmc.com.pk & procurement.hmc@gmail.com
 Web Site: http:// www.hmc.com.pk





HEAVY MECHANICAL COMPLEX LIMITED
Government Of Pakistan



PUN/TE/03

TENDER ENQUIRY FOR RRC YEAR 2026-27.

NO. MW/RRC-26-006	Date: 05-06-26	Due on: 18-06-26
M/s _____		This schedule duly filled in & signed, may also be returned with your offer.

We invite you to submit your sealed quotation for the supply of following stores on **Free Delivery HMC (FFW)** basis. Please ensure that your quotation must reach the Head (SCM) by 1400hours for opening in public at 1430hours on due date.

S.NO.	DESCRIPTION	QUANTITY	UNIT	RATE (RS.)
1	Partal Wood 6" x 10" x 10Ft	1,000	CFT	
2	Kail Wood 5" x 10" x 10Ft	2,000	CFT	
<p>Note:</p> <ul style="list-style-type: none"> - Procurement will be made on as and when required basis during the contract period from 1st July 2026 to 30th June 2027. - GST will be paid as per Government Rules. - Tender Fee Rs. 1500/- on the name of MD-HMC in form of CDR must be attached alongwith offer. 				

[Signature]
Head (Supply Chain Management)
Heavy Mechanical Complex Taxila.

Declaration:

I / We certify that I / We have read all the terms and conditions (1-25) of the Tender Enquiry overleaf and the same are fully acceptable to me / us. Following documents are enclosed :

- a. Bid Money: _____
- b. Sales Tax Registration Certificate / No. _____
- c. National Tax No. _____

Signature _____
Name _____
Firm's Name _____
Address _____

Tele No. _____
Fax No. _____



Taxila : 47050 Pakistan Phones : (+92-51) 9270562 (5 Lines), (+92-51) 9314181
Fax: (+92-51) 9270560, (92-51) 9314202, 3
Email: hmcengg@hmc.com.pk, marketing@hmc.com.pk & procurement.hmc@gmail.com
Web Site: http:// www.hmc.com.pk



TENDER ENQUIRY

NO.	FFW-26-017	Date :	08-Jun-26	Due on :	23-Jun-26
-----	------------	--------	-----------	----------	-----------

M/s.

Please ensure to indicate your offer in this schedule. In case of shortage of space, you may use your letterhead but this schedule is to be returned duly filled in & signed.

We invite your sealed bid on FOR / FOT Taxila or Free Delivery, HMC, Taxila basis for the supply of following store (s) precisely according to the format depicted below. Bid must reach HMC by 1400 hours for opening in public at 1430 hours on due date.

S. NO.	DESCRIPTION	Unit.	Qty.	Unit Price (Rs.)	Delivery Period
1	Yellow Dextrine Powder	Kgs	1400		
2	Glass Wool	Kgs	3000		
<p>- Tender Fee: Rs. 1,500/-</p> <p>Quotations submitted without the requisite 2% Bid Security and Tender Fee shall not be considered and will be rejected / returned on the spot.</p> <p>Important Note:</p> <ol style="list-style-type: none"> The offer shall be quoted on FOR Taxila basis. Delivery Period should be minimum. Quantity can be increased or decreased after tender opening if necessary. Validity: The offer validity should not be less than 30 days. Payment: Payment will be made after inspection & acceptance of stores at HMC Taxila. 					

NB: For Sales Tax and other Govt. levies please read clause 7 (e) of Terms and Conditions, overleaf.

Terms of Delivery : FOT/FOR Taxila - Free Delivery HMC Taxila.

Your offer No. & date : _____ Valid upto : _____

Additional Requirements : _____

Issued By :



Head Procurement Department
Heavy Mechanical Complex, Taxila.

DECLARATION

We certify that we have read the terms and conditions of the tender enquiry over leaf and the same are fully acceptable to us. We further agree to provide performance bond, if required.

Signature _____

Full Name _____

Seal of the Firm _____



HEAVY MECHANICAL COMPLEX

Government Of Pakistan



PUR/TE/02

TENDER ENQUIRY

NO.	FFW-26-016	Date :	08-Jun-26	Due on :	23-Jun-26
-----	------------	--------	-----------	----------	-----------

M/s.

Please ensure to indicate your offer in this schedule. In case of shortage of space, you may use your letterhead but this schedule is to be returned duly filled in & signed.

We invite your sealed bid on FOR / FOT Taxila or Free Delivery, HMC, Taxila basis for the supply of following store (s) precisely according to the format depicted below. Bid must reach HMC by 1400 hours for opening in public at 1430 hours on due date.

S. NO.	DESCRIPTION	Unit.	Qty.	Unit Price (Rs.)	Delivery Period
1	<p>LRF Castable</p> <p>As per attached specifications</p> <p>- Tender Fee: Rs. 1,500/-</p> <p>Quotations submitted without the requisite 2% Bid Security and Tender Fee shall not be considered and will be rejected / returned on the spot.</p> <p>Important Note:</p> <ol style="list-style-type: none"> 1. The offer shall be quoted on FOR Taxila basis. 2. Delivery Period should be minimum. 3. Quantity can be increased or decreased after tender opening if necessary. 4. Validity: The offer validity should not be less than 30 days. 5. Payment: Payment will be made after inspection & acceptance of stores at HMC Taxila. 	Kgs	5000		

NB: For Sales Tax and other Govt. levies please read clause 7 (e) of Terms and Conditions, overleaf.

Terms of Delivery : FOT/FOR Taxila - Free Delivery HMC Taxila.

Your offer No. & date : _____ Valid upto : _____

Additional Requirements : _____

Issued By :

Head Procurement Department
Heavy Mechanical Complex, Taxila.

DECLARATION

We certify that we have read the terms and conditions of the tender enquiry over leaf and the same are fully acceptable to us. We further agree to provide performance bond, if required.

Signature _____

Full Name _____

Seal of the Firm _____

Holder of ASME
Stamp Designator
U U2, S-PP and
The National Board
NB & R Stamp

Taxila : 47050 Pakistan Phones : (+92-51) 9270562 (5 Lines), (+92-51) 9314181
Fax: (+92-51) 9270560, (92-51) 9314202, 3
Email: hmcengg@hmc.com.pk, marketing@hmc.com.pk & procurement@hmc.com.pk
Web Site: http:// www.hmc.com.pk

TUV
AUSTRIA
HELLAS
EN ISO 9001:2015
Registration No.
2010113000011

UNDER ENQUIRY

PLB-26-034	Date:	04-Jun-26	Due on :	18-Jun-26
-------------------	--------------	------------------	-----------------	------------------

Please ensure to indicate your offer in this schedule, in case of shortage of space, you may use your letterhead but this schedule is to be returned duly filled in & signed.

To invite your sealed bid on FOR/FOT Taxila or Free Delivery, HMC, Taxila basis for the supply of following store (s) precisely according to the format depicted below. Bid must reach Procurement Department by 1400 hours for opening in public at 1430 hours on due date.

S. NO.	DESCRIPTION	Unit.	Qty.	Unit Price (Rs.)	Delivery Period
1	Rubber Seal as per Attached Sketch-1	Mtrs	300		
2	D-Type Seal as per Attached Sketch-2	Mtrs	25		

Tender Fee: 1,500/- Non refundable

Note: 2% Bid security is essentially required for quotation of Rs. 500,000/- or above otherwise quotation will not be acceptable.

Important Note:

- The offer shall be quoted on FOR Taxila basis.
- Delivery Period should be minimum.
- Quantity can be increased, decreased or deleted after tender opening, if necessary.
- Validity: The offer validity should not be less than 30 days.
- Payment: Payment will be made after inspection & acceptance of stores at HMC Taxila.

NB: For Sales Tax and other Govt. levies please read clause 7 (e) of Terms and Conditions, overleaf.
Terms of Delivery : FOT/FOR Taxila - Free Delivery HMC Taxila.

Your offer No. & date : _____ Valid upto : _____
Additional Requirements : _____

DECLARATION

We certify that we have read the terms and conditions of the tender enquiry over leaf and the same are fully acceptable to us. We further agree to provide performance bond, if required.

Signature _____
Full Name _____
Seal of the Firm _____

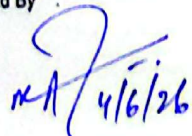
Issued By : 

Head Procurement Department
Heavy Mechanical Complex, Taxila.

Taxila : 47050 Pakistan Phones : (+92-51) 9314282-5 (4 Lines), (+92-51) 9314181-5 (5 Lines)
Fax: (+92-51) 9270203, (92-51) 9314260
Email: hmcengg@hmc.com.pk, marketing@hmc.com.pk & procurement.hmc@gmail.com
Web Site: http:// www.hmc.com.pk

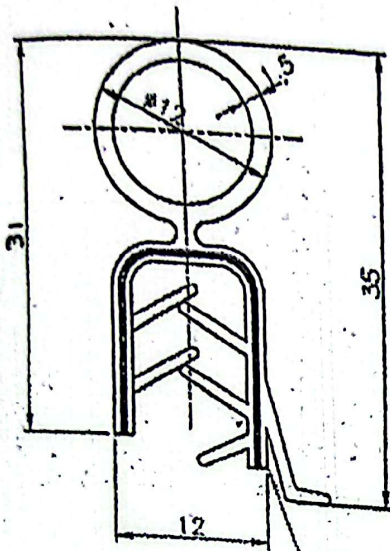

STEEL SPRING CORE

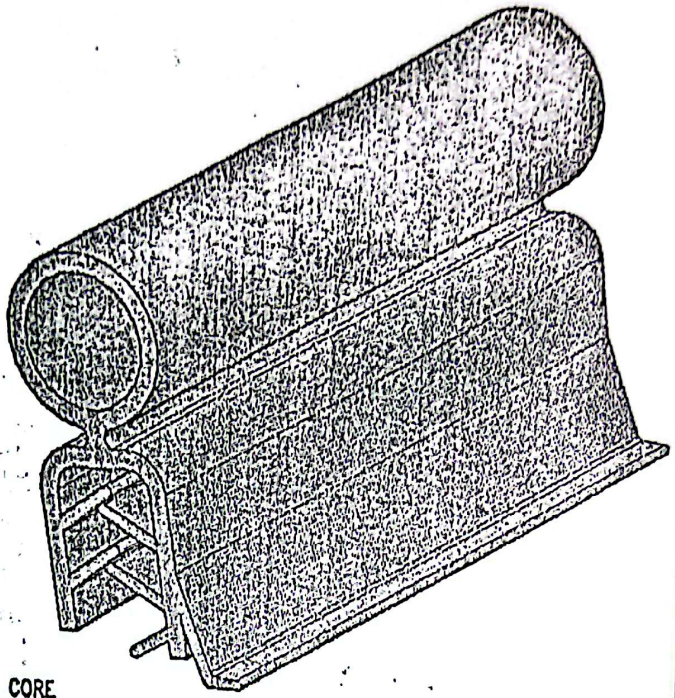

- SPONGE RUBBER EPDM (BLACK), HARDNESS 65±5 DUROMETER SHORE TYPE A

Div. 200000

- OTHER SPECIFICATIONS OF EPDM SHALL BE AS FOLLOWS
- TENSILE STRENGTH: 3000 PSI (MIN.)
- ELONGATION AT BREAK: 450% (MIN.)

<p>TITLE</p>	<p>SKETCH NO. <i>2/10/17</i></p> <p><i>[Signature]</i></p>
--------------	--

Sketch-1

Sketch-2

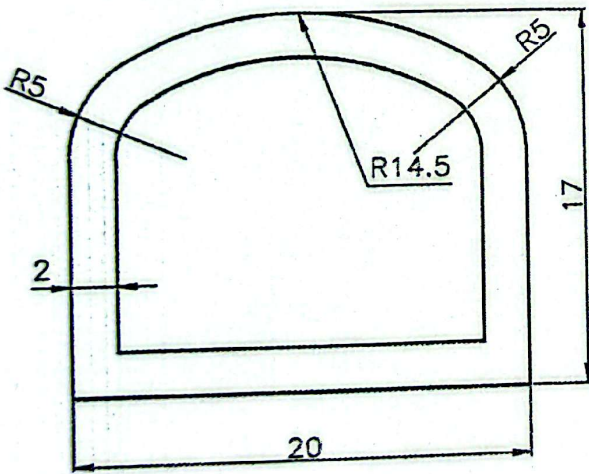

RUBBER SEAL

Signature
02-06-26



PUR/TE/02

TENDER ENQUIRY

PLH-26-035

Date:

04-Jun-26

Due on :

18-Jun-26

Please ensure to indicate your offer in this schedule. In case of shortage of space, you may use your letterhead but this schedule is to be returned duly filled in & signed.

Submit your sealed bid on FOR / FOT Taxila or Free Delivery, HMC, Taxila basis for the supply of following store (s) precisely as per the format depicted below. Bid must reach Procurement Department by 1400 hours for opening in public at 1430 hours on due date.

DESCRIPTION	Unit.	Qty.	Unit Price (Rs.)	Delivery Period
Face Mill Cutter Ø 50	Nos.	4		
Face Mill Cutter Ø 63	Nos.	4		
Face Mill Cutter Ø 100	Nos.	4		
Face Mill Cutter Ø 80	Nos.	4		
Mechanical Drill Bit Ø 72	Nos.	6		
Mechanical Drill Bit Ø 100	Nos.	6		
<p>Tender Fee: 1,500/- Non refundable Note: 2% Bid security is essentially required for quotation of Rs. 500,000/- or above otherwise quotation will not be acceptable.</p>				
<p>Important Note:</p> <ol style="list-style-type: none"> The offer shall be quoted on FOR Taxila basis. Delivery Period should be minimum. Quantity can be increased, decreased or deleted after tender opening, if necessary. Validity: The offer validity should not be less than 30 days. Payment: Payment will be made after inspection & acceptance of stores at HMC Taxila. 				

For Sales Tax and other Govt. levies please read clause 7 (e) of Terms and Conditions, overleaf.

Terms of Delivery : FOT/FOR Taxila - Free Delivery HMC Taxila.

Tender No. & date :

Valid upto : _____

Additional Requirements : _____

Signed By :

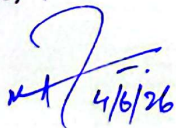
4/6/26

Head Procurement Department
 Heavy Mechanical Complex, Taxila.

DECLARATION

We certify that we have read the terms and conditions of the tender enquiry over leaf and the same are fully acceptable to us. We further agree to provide performance bond, if required.

Signature _____

Full Name _____

Seal of the Firm _____



HEAVY MECHANICAL COMPLEX
Government Of Pakistan



PURTE/02

TENDER ENQUIRY

Case No.:	PLE-26-054	Date:	08-Jun-26	Due on:	23-6-26
-----------	------------	-------	-----------	---------	---------

Please ensure to indicate your offer in this schedule. In case of shortage of space, you may use your letterhead but this schedule is to be returned duly filled in & signed.

The Tender must be accompanied by a non-refundable fee by means of a CDR/Demand Draft of Rs 1,500/- in favour of HMC, Taxila.

Sealed bids are invited on the basis of Free Delivery to HMC, Taxila for the supply of following items precisely according to the format depicted below. Bid must reach SCM Department by 1400 hours for opening in public at 1430 hours on due date.

Sr. NO.	DESCRIPTION	Unit	Qty.	Unit Price (Rs.)	Total (Rs.)
1	Half Coupling 1" (Thread)3000 # (ASME B16.11)	Nos	08		
2	Half Coupling 3/4" (Thread)3000 # (ASME B16.11)	Nos	08		
3	Hex Head Plug 1" (Thread)3000 # (ASME B16.11)	Nos	08		
4	Hex Head Plug 3/4" (Thread)3000 # (ASME B16.11)	Nos	08		
<p>Material : SA-105 MTC is Required</p>					
<p>1. Sealed bids are invited on the basis of Free Delivery to HMC, Taxila 2. Delivery Period should be max. upto 10 days. 3. The offer validity should not be less than 30 days. 4. Payment will be made after inspection & acceptance of stores at HMC Taxila. 5. Quantity can be increased, decreased or deleted if necessary after tender opening. 6. 2% Bid Security is essential to be submitted with quotation for total value of Rs. 500,000 /- or above.</p>					

Amount of GST shall be released against GST invoice & Income Tax shall be deducted as per Govt. prevailing rules.

Offer No.:

Dated:

Upto:

Issued By

For Head (SCM Department)
Heavy Mechanical Complex, Taxila.

DECLARATION

We certify that we have read the terms and conditions of the tender enquiry over leaf and the same are fully acceptable to us. We further agree to provide performance bond, if required.

Signature _____

Full Name _____

Seal of the Firm _____

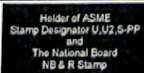

Taxila : 47050 Pakistan Phones : (+92-51) 9270562 (5 Lines), (+92-51) 9314181
 Fax: (+92-51) 9270560, (92-51) 9314202, 3
 Email: hmcengg@hmc.com.pk, marketing@hmc.com.pk & procurement.hmc@gmail.com
 Web Site: http:// www.hmc.com.pk

