



INVITATION TO BID / INSTRUCTIONS TO BIDDERS
SPARES FOR DOMESTIC & INDUSTRIAL GAS METERS
TENDER ENQUIRY # LE-023/26
OPENING DATE: 07.05.2026

1-A) We enclose one set of our Tender Enquiry for supply of subject noted items comprising of the following: -

i).	General Terms	Appendix 'A'
ii).	Schedule of Requirement and Delivery	Appendix 'B'
iii).	Technical Specifications	Appendix 'C'
iv).	Price Term Sheet	Appendix 'D'
v).	Specimen of Bid Bond	Appendix 'E'
vi).	Specimen of Performance/Warranty Bond	Appendix 'F'
vii).	Format of Authority Letter for attending public opening of bids (to be provided by the bidder's representatives to the bid opening Committee at the time of public opening of technical as well as commercial bids).	Appendix 'G'
viii).	Format of Integrity Pact under PPRA Rules, 2004	Appendix 'H'
ix).	Questionnaire / Commercial Sheet	Appendix 'I'
x).	Certificate of Full Disclosure and Non-Collusion	Appendix 'J'
xi).	Manner and Mechanism to Blacklisting / Cross Debarring of Supplier or Contractor	Appendix 'K'
xii).	Price Reasonability Certificate	Appendix 'L'

- 1-B) i). The bids against this tender enquiry are invited on single stage two envelopes system. The bids shall comprise a single package containing two separate envelopes. Each envelope shall contain separately the "TECHNICAL PROPOSAL" and the "FINANCIAL PROPOSAL".
The Technical and Financial Proposals must include amongst others, the following documents:
TECHNICAL PROPOSAL: following information/ documents should be submitted in technical proposal
- Documents required vide clause 3 of Appendix 'A' (Applicable Standards)
 - Technical Literature (clause 17 of Appendix 'A')
 - Documents required vide clause 21 of Appendix 'A' (Qualification of Bidder)
 - Questionnaire (Annexure-I)
 - Clause by clause commentary on technical specifications (Compliance sheet).
 - Professional Tax Clearance Certificate (clause 29 of Appendix-A).
 - Copy of Sales Tax Registration Certificate.
 - Copy of Income Tax Certificate.
 - Certificate of Full Disclosure and Non-Collusion
 - Price Reasonability Certificate
 - Integrity Pact
 - **Offered Delivery Schedule must be mentioned in the technical bid.**
 - **Original Bid Bond must be submitted in shape of Bank Guarantee/ Pay order as per tender clause # 10 page 3 of General Terms, Appendix-A and SOR Appendix-B. The original bid bond must reach us before closing time/ date of the tender enquiry; failing with bid will not be considered for evaluation.**
 - **Tender Documents Fee Rs. 2,500/- must be submitted in shape of Pay order separately favoring SNGPL.**
- ii). **FINANCIAL PROPOSAL:**
- Price term sheet (Appendix-D)
 - Questionnaire (Annexure-I)

Continued Page-2



(2)

Your quotation along with requisite documents complete in all respect duly signed/ stamped shall be submitted online through E-PADS (Federal PPRA) on or before 07.05.2026 at 1430 hours and will be opened publicly on the same date at 1500 hours.

It will be the responsibility of the bidder to submit their quotation before the closing time. The Company does not take any responsibility, whatsoever, of submission of bids at E-PADS.

Bids received after the bids opening date and time will not be considered as per PPRA Rules.

It is advised to interested bidders to submit their bids/ quotations online through Federal PPRA E-PADS as well as in hard form through courier or by hand.

NOTE: SUBMISSION OF TENDER IN HARD FORM

The bidders are also required to submit their quotations in the envelope marked as "TECHNICAL PROPOSAL" and "FINANCIAL PROPOSAL" in bold and legible letters to avoid confusion, and sealed properly.

The original plus copy each of "TECHNICAL" and "FINANCIAL PROPOSAL" of the bid must be enclosed in duplicate sealed cover. The inner and outer envelope must bear the word "CONFIDENTIAL Spares for Domestic & Industrial Gas Meters". Tender Enquiry No. LE-023/26 due for opening on 07.05.2026 and forwarded through courier or by hand at following address;

**GENERAL MANAGER PROCUREMENT, SUI NORTHERN GAS PIPELINES LTD,
GAS HOUSE, 1ST FLOOR, 21-KASHMIR ROAD, LAHORE-PAKISTAN.**

Bids / quotations will be received in this office on or before 07.05.2026 at 1430 hours and will be opened publicly on the same date at 1500 hours at the above-mentioned address. In case of holiday(s) falling on the date of bids opening bids / quotations will be opened at the same time on the next working day. It will be the responsibility of the bidder to deliver the bids before the closing time. The Company does not take any responsibility, whatsoever, of collection of bids from any agency. Bids / Quotations received after the bids opening date and time will not be considered and will be returned.

Initially, only the envelope marked as "TECHNICAL PROPOSAL" shall be opened. The envelope marked as "FINANCIAL PROPOSAL" shall be retained in the custody of SNGPL without being opened. During the technical evaluation no amendments in the technical proposal shall be permitted. Therefore, bidders are required to submit their offers complete in all respects.

After evaluation of the "TECHNICAL PROPOSAL" the company shall within the validity period, publicly open the financial proposals of the technically accepted bidder only at a time, date and venue announced and communicated in advance to all technically acceptable bidders.

The "FINANCIAL PROPOSALS" of the bids found technically non-responsive shall be returned unopened to the respective bidders.

2. The quotation submitted through online E-PADS (Federal PPRA) and hard form at above mentioned address shall be the same. In case of any contradiction/ difference, bid submitted through online E-PADS shall be considered for evaluation.

Continued Page-3

Registered Office:

Sui Northern Gas Pipelines Limited,
21- Kashmir Road, Lahore, Pakistan.
+92-42-99082000-06

www.sngpl.com.pk

Head Office:

21- Kashmir Road, Lahore, Pakistan.
+92-42-99082000-06



(3)

3. Your firm and irrevocable offer in Pak rupees must be based on free delivery at our mentioned specified stores.
4. The delivery must conform to the terms given in the Schedule of Requirement and Delivery (Appendix 'B') and must be strictly adhered to. Earlier delivery will also be acceptable.
5. General Terms attached as Appendix-A, must be taken into consideration before submitting your quotation.
6. Your offer must remain open for a period of 60 days from the closing date of the tender.
7. If you have any doubts as to the meaning of any portion of the specifications or "General Terms", you should when submitting your bid, set out in your covering letter, the interpretation upon which you rely.
8. We reserve the right to increase / decrease the tender quantities or cancel this enquiry in whole or in part before tender opening should our requirement change in the meantime. After tender opening, the quantities may be increased / decreased by 15% of the tender quantities. However, decrease beyond 15% shall be subject to concurrence by the successful bidder.
9. We also reserve the right to have items inspected by a third-party inspector at our own expense.
10. It must be indicated by the bidders in their offers/quotations that their quotation fully conforms to technical specifications and to the terms and conditions of the tender enquiry.
11. Only one authorized representative of bidder will be allowed to attend the public opening of bids, who will be required to submit an authority letter (as per specimen attached as Appendix 'G') in his favor issued by the respective bidders(s) for attending the public opening of bids, failing which he will not be allowed to attend the public opening.
12. Any attempt to obstruct competition by any means including formation of cartels will lead to rejection of your bid. Furthermore, this may also lead to de-listing for your firm from list of approved / pre-qualified manufacturers of the tendered item.
13. If needed be, please contact Mr. Haider Abbas Dy. Chief Officer (Procurement) Ph: # 042-99085026, E-mail: haider.abbas@sngpl.com.pk
14. It is contractor's responsibility to take measures as per General Procedure of HSE in view of the environmental health, safety law and regulations, which is available at www.sngpl.com.pk.
15. Blacklisting and Debarment of bidders and suppliers shall be as per PPRA Rule No.19.
16. Bidders are required to submit their firm and irrevocable offer in Pak Rupees inclusive of all Govt. Taxes, Duties & Levies etc. except Sales Tax, which must be based on free delivery at our specified stores / location. The amount of Sales Tax, where applicable, would be mentioned separately. In case GST is not mentioned separately, it shall be considered that offered bid price is inclusive of GST. However, bidder may be required to provide documentary evidence regarding application or exemption of sales tax as mentioned in bid, if required by us during evaluation of bids or after placement of order / contract. Payment of sales tax shall be made as per prevailing Govt. rules / regulations."

Yours faithfully,
SUI NORTHERN GAS PIPELINES LIMITED
(HAIDER ABBAS)
DY. CHIEF OFFICER (PROCUREMENT)
for MANAGING DIRECTOR ✓

Tender Enquiry No. LE-023/26 Due On: 07.05.2026

Instrument No. _____ Dated _____ Amount Rs. _____



SCHEDULE OF REQUIREMENT/DELIVERY
TENDER ENQUIRY No. LE-023/26

The approximate total requirement of **“COVERING SPARES FOR DOMESTIC & INDUSTRIAL GAS METERS”** and delivery required is as under: -

SR. #.	Description	Qty. Nos.	Bid Bond Valuing (Rs.)	No. of samples required	Delivery Required
1.	S.S Sealing Wire 7 Layers	250,000 Fts	45,000	5-10 ft.	Delivery Required Within 6- 8 weeks after receipt of purchase order at our SNGPL Gulberg Stores Gurumanget Road, Lahore.
2.	Capillary Nut BS	5500	8,250	02 Nos.	
3.	Hexagonal 13 head bolt for EVC Base Plate	6,000	2,400	02	
4.	Roots Meter Body Plug	5,004	8,006	02	
5.	Counter Shaft for Romet Meter	3,000	15,000	02	
6.	Meter Counter Base Sheet, A1-800/1000/1400/2300 Meter)	1,000	8,000	--	
7.	Reverse Gas Flow Blockers (NRV) For SSGC/G-4 Meters	55,000	11,900	50	
8.	Index Plastic Cup Seal (Large) for Zenner G-1.6 Meter	60,000	3,159	50	
9.	Body & Front / Back Plastic Cup Seal (Small) for Zenner G-1.6 Meter	100,000	5,265	50	
10.	Index Plastic Cup Seal for BK Elster G-1.6 / 2.5/ 4/ 6 Meter	20,000	1,080	50	
11.	Body Plastic Cup Seal for BK Elster G-1.6 / 2.5/ 4	20,000	880	50	
12.	Body Plastic Cup Seal Sensus G-4/G-& BK G-5 Meters	20,000	770	50	
13.	Index & Body Plastic Cup Seal for Deasung G-4 Meter	50,000	1,350	50	
14.	Dust Cap for BK Meters	22,000	2,495	--	
15.	Plastic Cap for Domestic meter	112,000	7,121	--	
16.	L-Key sealing bolt for MKM meter counter, size 4mm * 10mm	500	190	04	
Total Rs.			120,866/-		

(For Item Nos. 01-16 detailed Drawings / Technical Specifications are attached as Appendix-‘C’)

Notes:-

- ❖ All the bidders are required to **submit samples (Non-Returnable)** for testing / inspection purposes along with quotations for our technical evaluation.
- ❖ **Provided the samples must comply with all clauses of the technical specifications / drawings of the tender enquiry. In case sample received with bid is not found in conformance of the tender specifications, no chance will be given to submit any improved samples.**









1.	Bidder must conform to the specified tender terms.
2.	During the course of evaluation, if any clarification is required from bidder, the timeline for submission of response must be adhered to, failing which the bid may not be considered for further processing.
3.	Please quote your firm and irrevocable prices(s) for free delivery at our specified Stores / location including all Government taxes / duties, transportation, unloading, stacking at above mentioned Stores but Excluding of sales tax on the end product offered by you. Sales tax on finished goods may be reimbursed to you on the basis of documentary evidence for being paid the sales tax to relevant Government authorities, as per prevailing Govt. rules.
4.	Please note that the following Price Reasonability Certificate must be submitted along with your quotation as per Appendix "L" : - "Certified that the prices quoted against subject Tender Enquiry are not more than the prices charged from any other purchase organization and in case of any discrepancy the tenderer / bidder hereby undertakes to refund the price charged in excess."
5.	The bidders are required to provide complete details of orders in hand with them along with delivery period start to end and of tenders against which bidder / manufacturer has already participated against tenders of different organizations including SNGPL. Pursuant to above, the bidder should demonstrate the compliance to the delivery schedule stated in the present tender enquiry by a bar chart showing the delivery of orders in hand and that of the present tender enquiry. Any departure from this clause may make the bid liable to rejection.
6.	PACKING: -The material (if required) should be packed suitably for safe transportation / handling / storage etc.
7.	INSPECTION: -Inspection / testing of above subject item will be undertaken by SNGPL Engineers at Lahore Area Gulberg stores Gurmanget Road, Lahore. It shall however, not absolve the supplier/manufacturer to supply the goods and carry out quality control in accordance with the specifications and standards mentioned in this tender and purchase order.
8.	The Company reserves the right to reject any bid received from any bidder who have defaulted the supply fulfillment contractual obligations etc. with respect to supply / services against previous purchase order(s) placed on them.
9.	Only those manufacturers can participate in this tender enquiry who in the absolute discretion of SNGPL are eligible to do so.
10.	We require delivery as per above mentioned schedule / period, you however may quote your best delivery schedule period.
11.	Material should be supplied as per our specification, sub-standard / defective material will have to be replaced by you on 'NO CHARGE BASIS' even after our acceptance.
12.	Bidders are required to complete "Appendix-I" (Questionnaire Form) attached with the tender enquiry and return it with their quotation.
13.	The Company reserves the right to extend the opening date of tender enquiry without assigning any reason and to reject all offer without assigning any reasons as per PPRA Rule- 33.
14.	In case goods supplied by you are found sub-standard at any stage, you will be required to replace at your own cost within 7- days of receipt of written letter from us to that effect.
15.	Your offer should be accompanied by a copy of valid Sales Tax Registration, NTN and Professional Tax clearance certificate in your name, failing which the offer will not be considered for evaluation.
16.	Sales Tax will be paid to you on submission of documentary evidence.
17.	Conditional bids are liable for rejection. For example, but not limited to: - (i) Rate of exchange fluctuation, Partial Order acceptance, Govt. Duties & Taxes etc.
18.	Bidder in their quotation writes the prices in figures as well as in words. In case of any dispute between unit price, and total price, the unit price shall prevail.
19.	Discount, if any, should be boldly shown under the prices. Discount, if conditional or not read at the time of bid opening shall not considered during bid evaluation.
20.	We reserve the right to increase/decrease the quantities or cancel this enquiry in whole or in part before tender opening should our requirement change in the meantime. After tender opening, the quantities may be increased / decreased by 15% of tender quantities. However, decrease beyond 15% shall be subject to concurrence by the successful bidder.
21.	Your deliveries are liable to be tested / physically inspected by us and if you fail to supply the material according to our specifications we reserve the right to cancel the purchase order.

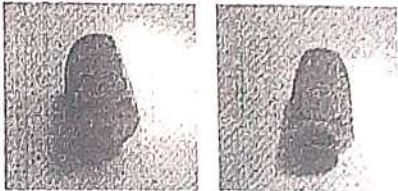

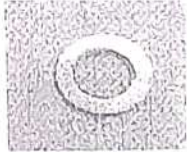
22.	Bids will be evaluated and accepted for above offered quantity. No bid will be acceptable for lesser than quantity than specified above in the schedule of requirement.
23.	Please indicate clearly your reservations if any, to the terms and conditions of the tender enquiry, on the quotation.
24.	Reservations/clarifications, if any w.r.t tender terms/specifications should be asked by the bidders 05 days prior to the closing date of the tender.
25.	It is contractor's responsibility to take measures as per General Procedure of HSE in view of the environmental health, safety law and regulations, which is available at www.sngpl.com.pk .
26.	Bidder is required to be on Active Taxpayer List of FBR for obtaining tender documents & quoting bid against tender enquiry.
27.	The following documents / information must be provided along with the bid: - ➤ Name of the bidder. ➤ Type of ownership i.e. Proprietor / Partnership / Private Limited Company /Public Limited Company. Following relevant papers must be provided in respective cases: - ➤ Copy of NIC in case of single proprietor/ Copy of Partnership deed in case of partnership/ Copy of Article of Association for Private / Public Limited Companies. ➤ Date of establishment of business concern ➤ GST Number along with copy of certificate. ➤ National Tax Number along with copy of certificate. ➤ Professional Tax Clearance Certificate (2025-26)
28.	Please provide your firm's official E-mail ID & Website (if any) Contact Numbers in your bid for correspondence. E-Mail ID. Website. Contact Numbers.
29.	The bidder is required to provide below mentioned details in their bids failing which their online payment as per FBR directive may delay for the want of mandatory details.

Sr. No.	Name of Supplier	Account Name	IBAN Account Number	Account Number	Account Title / Name	Bank Name	Branch Name	Branch Code

Sr. No.	Description	Pictures
1	<p>S.S. Sealing Wire 7 Layers</p> <ol style="list-style-type: none"> 1. Length of wire = As per indent (wire should be properly wound on suitable spools) 2. No. of strands of wire = 7 3. Diameter of standard rope = 0.7 mm (22G) 4. Diameter of each strand = 0.23 mm (34 G) 5. Material = Stainless Steel (S.S316) (The stranded wire rope should be soft so that it could be used with Twist Tite Seals) 6. Material testing certificate preferably validating material is = Stainless Steel (S.S316) grade 7. S.S Seal Wire Material should free from magnetic influence. 8. Approximately 5 to 10 ft sample required for testing and evaluation. 	
2	<p>Capillary Nuts BS</p> <ol style="list-style-type: none"> 1. Hexagonal across the flats = 14mm 2. Total Length = 18 mm 3. Inner threaded portion length = 10 mm 4. Upper hole for capillary diameter = 3.4 mm 5. Inner thread pitch = 5/16"x24 Gauge 6. 01 No. hole on head for sealing Ø 2 mm 7. Material Brass. 8. Material should be of Superior Quality without any cracks to avoid any leakage. 9. 02 Nos. pieces required as sample for testing and evaluation. 	
3	<p>Kerosene Oil Superior Quality</p>	
4	<p>Capillary Bush</p> <ol style="list-style-type: none"> 1. Outer diameter = 5 mm 2. Inner diameter = 3.3 mm 3. Total Length = 6.6 mm 4. Both Side Chamfered Size = 2 mm 5. Material Brass. 6. Material should be of Superior Quality without any cracks to avoid any leakage. 7. 06 Nos. pieces required as sample for testing and evaluation. 	
5	<p>Plain Washer for Actaris meter EVC Fixing and AL 800/1000</p> <ol style="list-style-type: none"> 1. Inner Dia: 6.6mm 2. Outer Dia: 12.8mm 3. Thickness: 1.6mm 4. Material: MS 5. Material should be of Superior Quality. 6. 02 Nos. pieces required as sample for testing and evaluation. 	
6	<p>Teflon Tape, 1/2" width, 0.004" thickness</p> <ol style="list-style-type: none"> 1. 12 mm x 10 m x 0.1 mm (width x Length x Thickness) 2. High Pressure resistance greater than or equal to 175 psig 3. Tensile strength greater than or equal to 8 mpa 4. Percentage elongation greater than or equal to 25% 5. Heat resistance to 60°C 6. 02 Nos. pieces required as sample for testing and evaluation. 	

7	Washer for EVC Bolt Fixing <ol style="list-style-type: none"> 1. Inner Dia 8mm 2. Outer Dia - 15mm 3. Thickness: 1.6mm 4. Material: MS 5. Material should be of Superior Quality. 6. 02 Nos. pieces required as sample for testing and evaluation 	
8	Hexagonal 1.8 head bolt for EVC base plate <ol style="list-style-type: none"> 1. Hexagonal Head: 15" 2. Material M/S 3. Thread Pitch 5/16 - 18 4. Threaded Portion Length 19mm 5. 2mm hole in head for sealing wire 6. 02 Nos. pieces required as sample for testing and evaluation 	
9	Anti-Caste Spray (BYD-30) 400 ml / Tin (02 Nos. pieces required) <ol style="list-style-type: none"> 1. Stops Squeaks 2. Drive Out Moisture 3. Clear and Protects 4. Loosens Rusted Parts 5. Frees Sticky Mechanism 6. Packing Quantity 230 ml ~ 400ml 7. Material Should be of Superior Quality 	
10	Samad Bond <ol style="list-style-type: none"> 1. Physical State: Viscous Liquid 2. Color: Yellow, Opaque 3. Odour: Solvent-like 4. Solubility: Insoluble in water 5. Each pack of 80 gram 6. Shelf life at the time of supply: 1 or more year 7. 02 Nos. pieces required for sample 	
11	Enamel Paint - Light Blue RAL 5012 <p>Physical Data</p> <ol style="list-style-type: none"> 1. Color - ISS/ RAL/ Custom Shades 2. Finish - Glossy (80-95 GU at 60° angle) 3. Shelf Life - 12 months <p>Drying Characteristics</p> <ol style="list-style-type: none"> 1. Surface Dry - 20 mins 2. Touch Dry (to Handle) - 1.0 Hours 3. Hard Dry - 24 Hours 4. Full Cure - 7 Days 5. Over coating Interval - 24 Hours <p>Application Data</p> <ol style="list-style-type: none"> 1. Application Method - Spray/ Airless Spray/Brush/ Roller 	Appendix C
12	ROV'S METER BODY PLUGS <ol style="list-style-type: none"> 1. Hexagonal across the flats = 19 mm 2. Circular neck diameter = 17 mm 3. Threaded portion diameter = 14 mm 4. Total length = 25 mm 5. Head length = 09 mm 6. Neck length = 03 mm 7. Threaded portion length = 13mm 8. Thread pitch = 9/16 x 18G 9. 01 No. hole on head for sealing = 2 mm 10. O-Ring after threads with neck 11. O-Ring size, ID = 11 mm, Cord Ø 2.6 mm 12. Material = Aluminum 13. 02 Nos. pieces required as sample for testing and evaluation 	

Technical Bid Evaluation Criteria:

Offers of the bidders will be evaluated strictly in accordance with the above stated criteria.

69

Appendix - 'C'
(14)

Ho/MT/LP/0064/25

Technical Specification of Rotary Meter Counter Shaft

- Material = Stainless Steel 304
- Hardness = Greater than or equal to 38-42 Rockwell C
- Length = 67 mm
- Diameter = 3.2 mm
- Bearing shafts should have highly machined surface up to $0.4\mu\text{m ra}$
- Two flats of length 6 mm from each end to ensure positional retentions of gears through grub screws.
- Position of flat surfaces should be 6 mm from each end
- Depth of flat surfaces = 0.4 mm
- Shaft ends should be Filleted at $0.2r$
- Application of lubrication on finished product to avoid scaling
- The bidder should submit the details of Manufacturing processes along with the bid offer which may include following:
 1. Drawing
 2. Straightening
 3. Sizing
 4. Filleting
 5. Milling
 6. Hardening
 7. Centerless grinding



Note:

- i. Bidder is required to submit 02 Nos. samples of shaft along with his bid offer meeting the above specifications.
- ii. Bidder may visit Central Meter Shop, Kot Lakhpat Lahore to understand the tender technical specification, objectively.
- iii. Soft copy of drawing can be shared with bidders upon request through email.

67

Appendix - C

Ho / MIP / IP / 0064 / 25

Meter Counter Base Sheet, AL-800/1000/1400/230

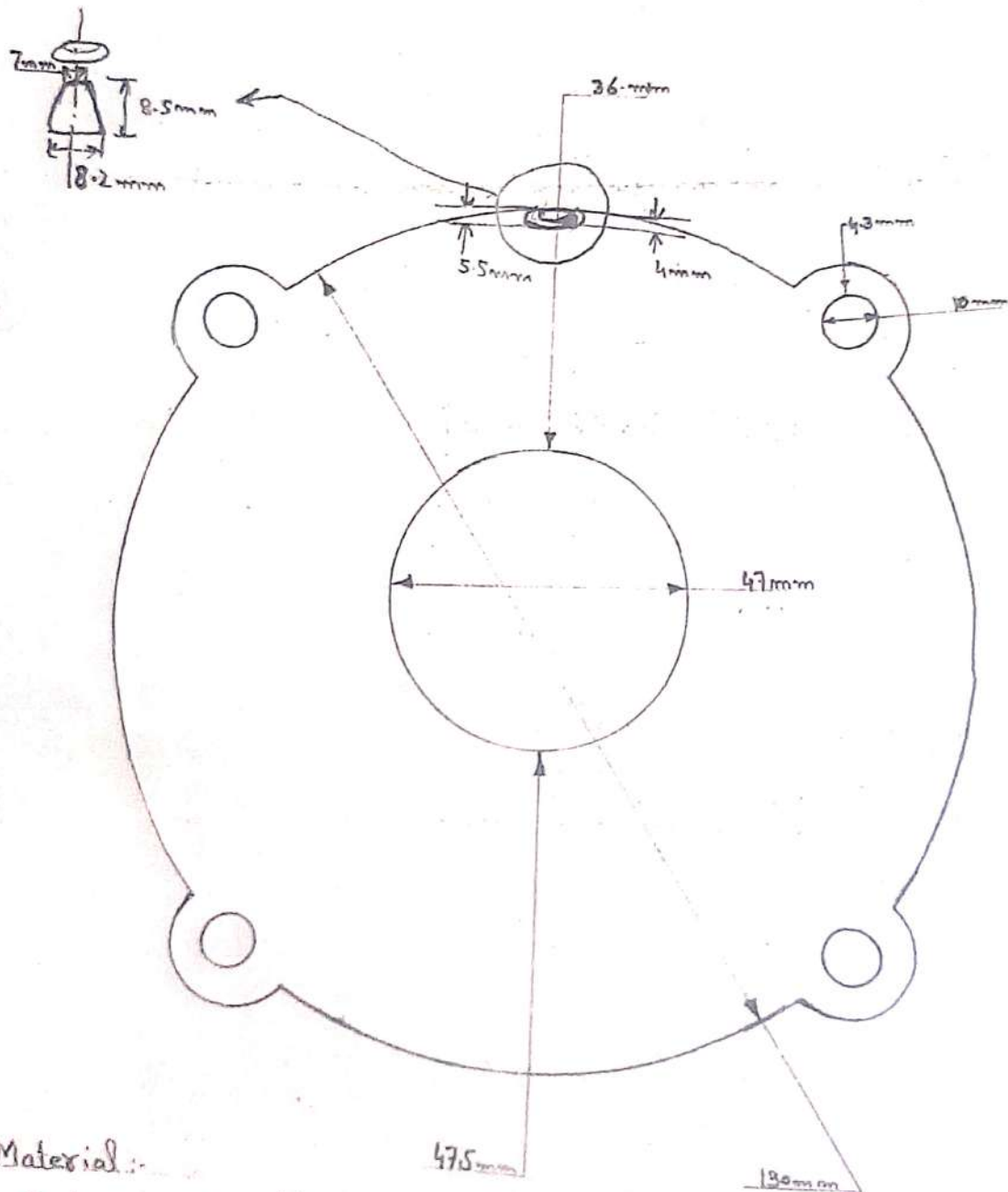

Material:

Polycarbonate / Polycarbonate

Thickness: 3.0mm

Reverse Gas Flow Blocker (NRV) for G-4 Meters

Technical Specifications

- i. Length of outlet port where NRV needs to be fixed in: 26.52 mm
- ii. Width of outlet port where NRV needs to be fixed in: 15.65 mm
- iii. Material of construction is Polystyrene.
- iv. Dimensions of NRV (View 3 & View 4) should be according to dimensions mentioned at View-1 and View-2, so that it can easily be installed without any leakages.
- v. Flapper Type Non Return Valve to cater the reverse flow of gas.
- vi. Sealing rings may be installed to prevent reverse gas flow.
- vii. Flapper's design should be compatible to freely move inside tapered portion of outlet port. (View-1 & View-2)
- viii. Maximum reverse gas flow limit is 5 CFT/hr.
- ix. Maximum pressure drop across the meter after installation of NRV should not be more than 0.8" W.C.

Pictures are given below:

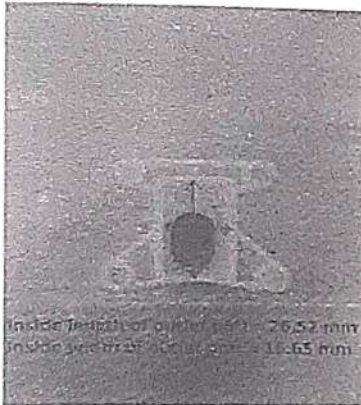

View-1 where NRV is to be fixed



View-2 Where NRV is to be fixed



View-3 of Reverse Gas Flow Blocker

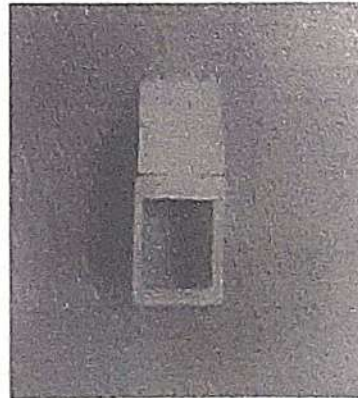

View-4 of Reverse Gas Flow Blocker

Bid Evaluation Criteria

Offer of the bidder will be evaluated strictly in accordance with above stated technical specifications.

Sample

Each bidder should submit 50 Nos. Samples free of cost for testing and evaluation purpose

Delivery

Delivery Period is 6 to 8 weeks.

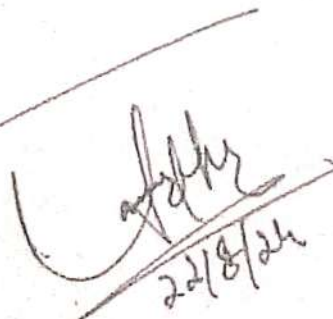
22/8/24

Meter type: zone
 All Dimensions are in MM
 Hidden Line : Dotted Line
 Material:

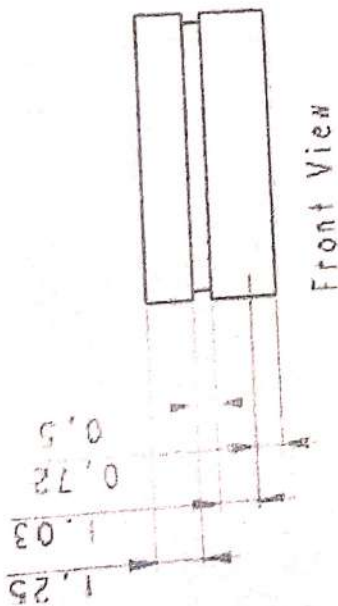

Isometric View

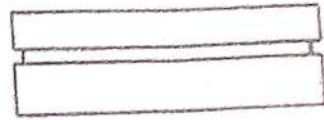

Side View

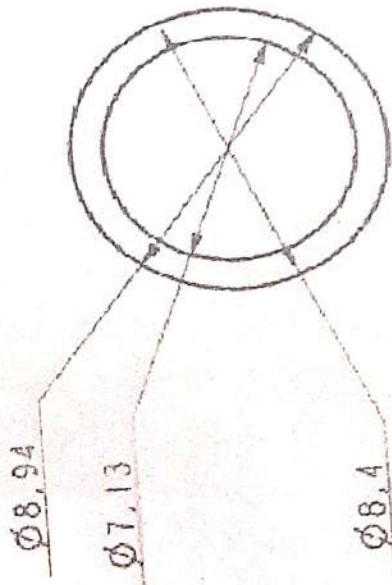

Top View

[Handwritten signature]
 1328-1

Technical Bid Evaluation Criteria:

Offers of the bidders will be evaluated strictly in accordance with the above stated technical specifications

SPECIFICATION OF SEAL

Body & Front Back Plastic Cup Seal (Small) Zenner G-1.6

MATERIAL POLY ACETAL:

Material used to manufacture Cup Seal shall be "Poly Acetal". The colour of the material shall be red. All Plastic cup seals shall be of UV Resistant material so that the seal shall withstand the sunlight and environmental/ weather effect, without any deformation or change in color for a long period of time.

MANUFACTURING:

The Cup Seal shall be manufactured dimensionally in accordance with the measurements given in the drawing.

EDGES:

All edges of Cup Seal shall be uniform and free of any burr.

SNGPL MONOGRAM:

SNGPL monogram shall be embossed on the top of the head of the Cup Seal.

FINISH:

The Cup Seal shall maintain dimensional accuracy, free of burrs, cuts or any other physical damage.

SAMPLE:

Each bidder shall submit fifty (50) samples free of cost for testing and evaluation purpose.

DELIVERY PERIOD:

Delivery Period 6-8 weeks.

NOTE:

All the bidders shall ensure that bid documents as well as seal dimensions/ design/impression should be kept most confidential and shall not supply these seals others then SNGPL.



Technical Bid Evaluation Criteria:

Offers of the bidders will be evaluated strictly in accordance with the above stated technical specifications

Meter Type: Jernet
 All Dimensions are in mm
 Material:

0.85
 0.95



Front view



Isometric View



Side View

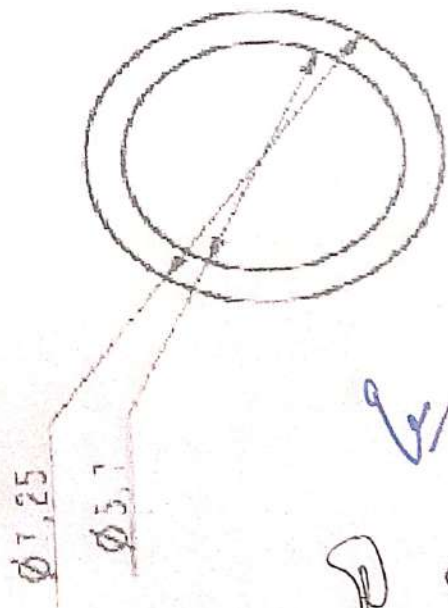

Top View

Handwritten initials and a signature in blue ink.

1328-1
 Handwritten signature and number.

Technical Bid Evaluation Criteria:

Offers of the bidders will be evaluated strictly in accordance with the above stated technical specifications

SPECIFICATION OF SEAL

Index Plastic Cup Seal for BK Elster G-1.6/2.5/4 Meter

MATERIAL POLY ACETAL:

Material used to manufacture Cup Seal shall be "Poly Acetal". The colour of the material shall be red. All Plastic cup seals shall be of UV Resistant material so that the seal shall withstand the sunlight and environmental/ weather effect, without any deformation or change in color for a long period of time.

MANUFACTURING:

The Cup Seal shall be manufactured dimensionally in accordance with the measurements given in the drawing.

EDGES:

All edges of Cup Seal shall be uniform and free of any burr.

SNGPL MONOGRAM:

SNGPL monogram shall be embossed on the top of the head of the Cup Seal.

FINISH:

The Cup Seal shall maintain dimensional accuracy, free of burrs, cuts or any other physical damage.

SAMPLE:

Each bidder shall submit fifty (50) samples free of cost for testing and evaluation purpose.

DELIVERY PERIOD:

Delivery Period 6-8 weeks.

NOTE:

All the bidders shall ensure that bid documents as well as seal dimensions/ design/impression should be kept most confidential and shall not supply these seals others then SNGPL.

✓
D
1328-1

Technical Bid Evaluation Criteria:

Offers of the bidders will be evaluated strictly in accordance with the above stated technical specifications.

BK47-SCA6

All dimensions are in MM
Hidden lines = Dotted Line
Material:

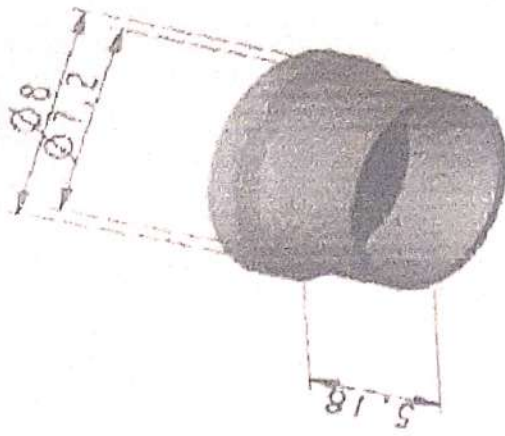

Isometric View



Side View

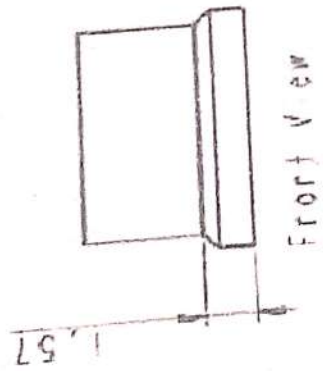

Front View

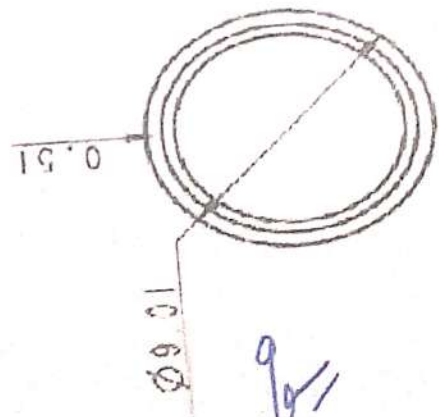

Top View

[Handwritten signature]
[Handwritten signature]
1328-1

Technical Bid Evaluation Criteria:

Offers of the bidders will be evaluated strictly in accordance with the above stated technical specifications

SPECIFICATION OF SEAL

Body Plastic Cup Seal for BK Elster G-1.6/2.5/4 Meter

MATERIAL POLY ACETAL:

Material used to manufacture Cup Seal shall be "Poly Acetal". The colour of the material shall be red. All Plastic cup seals shall be of UV Resistant material so that the seal shall withstand the sunlight and environmental/ weather effect, without any deformation or change in color for a long period of time.

MANUFACTURING:

The Cup Seal shall be manufactured dimensionally in accordance with the measurements given in the drawing.

EDGES:

All edges of Cup Seal shall be uniform and free of any burr.

SNGPL MONOGRAM:

SNGPL monogram shall be embossed on the top of the head of the Cup Seal.

FINISH:

The Cup Seal shall maintain dimensional accuracy, free of burrs, cuts or any other physical damage.

SAMPLE:

Each bidder shall submit fifty (50) samples free of cost for testing and evaluation purpose.

DELIVERY PERIOD:

Delivery Period 6-8 weeks.

NOTE:

All the bidders shall ensure that bid documents as well as seal dimensions/ design/impression should be kept most confidential and shall not supply these seals others then SNGPL.

[Handwritten initials]
[Handwritten signature]
132-08-1

Technical Bid Evaluation Criteria:

Offers of the bidders will be evaluated strictly in accordance with the above stated technical specifications

2019-2024

All Dimensions are in MM
Hidden line = Dotted Line
Material:

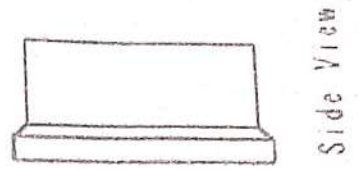
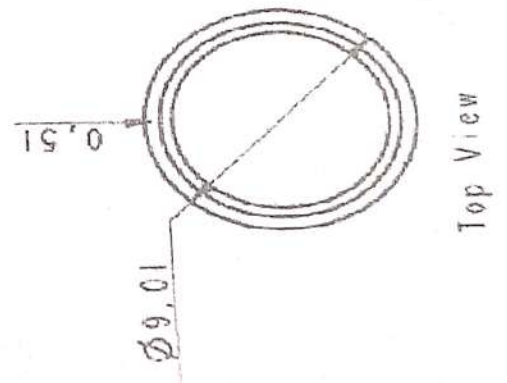
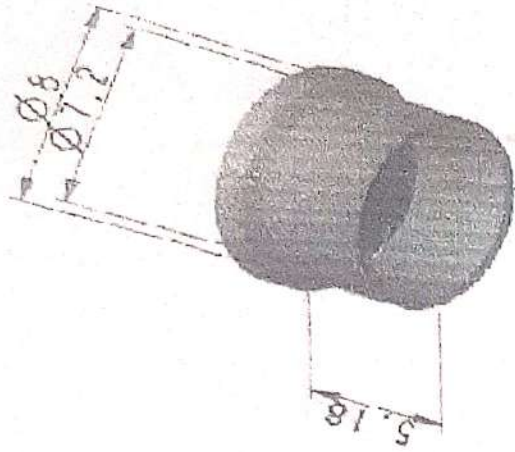
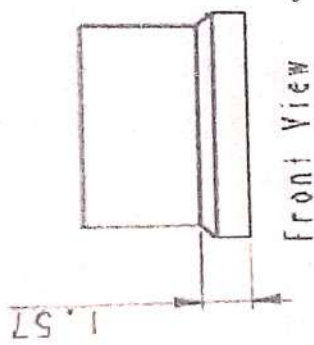

Technical Bid Evaluation Criteria:

Offers of the bidders will be evaluated strictly in accordance with the above stated technical specifications

SPECIFICATION OF SEAL

Body Plastic Cup Seal Sensus G-4/G-6 & BK G-6 Meter

MATERIAL POLY ACETAL:

Material used to manufacture Cup Seal shall be "Poly Acetal". The colour of the material shall be red. All Plastic cup seals shall be of UV Resistant material so that the seal shall withstand the sunlight and environmental/ weather effect, without any deformation or change in color for a long period of time.

MANUFACTURING:

The Cup Seal shall be manufactured dimensionally in accordance with the measurements given in the drawing.

EDGES:

All edges of Cup Seal shall be uniform and free of any burr.

SNGPL MONOGRAM:

SNGPL monogram shall be embossed on the top of the head of the Cup Seal.

FINISH:

The Cup Seal shall maintain dimensional accuracy, free of burrs, cuts or any other physical damage.

SAMPLE:

Each bidder shall submit fifty (50) samples free of cost for testing and evaluation purpose.

DELIVERY PERIOD:

Delivery Period 6-8 weeks.

NOTE:

All the bidders shall ensure that bid documents as well as seal dimensions/ design/impression should be kept most confidential and shall not supply these seals others then SNGPL.

Handwritten marks:
A stylized signature or mark resembling 'W' or 'V' in blue ink.
A signature in blue ink, possibly 'R. Akhter', with the number '13288-1' written below it.

Technical Bid Evaluation Criteria:

Offers of the bidders will be evaluated strictly in accordance with the above stated technical specifications

SENSUS 46/94 BODY SEAL

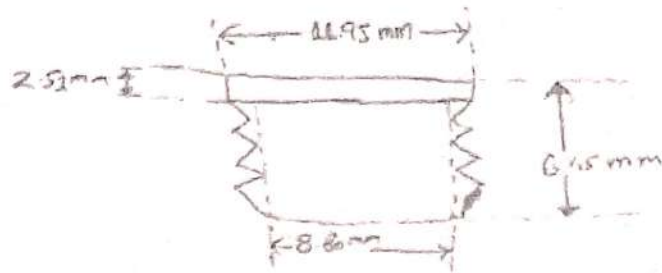

- Ball thickness = 1.575 mm
- Thread depth = 0.5 mm
- Thread pitch = 1 mm
- Cap thickness = 2.51 mm
- Inner diameter = 8.80 mm
- outer diameter = 11.95 mm

[Signature]
1328-1

Technical Bid Evaluation Criteria:

Offers of the bidders will be evaluated strictly in accordance with the above stated technical specifications

SPECIFICATION OF SEAL

Index & Body Plastic Cup Seal for Deasung G-4 Meter

MATERIAL POLY ACETAL:

Material used to manufacture Cup Seal shall be "Poly Acetal". The colour of the material shall be red. All Plastic cup seals shall be of UV Resistant material so that the seal shall withstand the sunlight and environmental/ weather effect, without any deformation or change in color for a long period of time.

MANUFACTURING:

The Cup Seal shall be manufactured dimensionally in accordance with the measurements given in the drawing.

EDGES:

All edges of Cup Seal shall be uniform and free of any burr.

SNGPL MONOGRAM:

SNGPL monogram shall be embossed on the top of the head of the Cup Seal.

FINISH:

The Cup Seal shall maintain dimensional accuracy, free of burrs, cuts or any other physical damage.

SAMPLE:

Each bidder shall submit fifty (50) samples free of cost for testing and evaluation purpose.

DELIVERY PERIOD:

Delivery Period 6-8 weeks.

NOTE:

All the bidders shall ensure that bid documents as well as seal dimensions/ design/impression should be kept most confidential and shall not supply these seals others then SNGPL.

Technical Bid Evaluation Criteria:

Offers of the bidders will be evaluated strictly in accordance with the above stated technical specifications

D
A. B. B. B.
1328-1

Index and Body Plastic Cup Seals
For Deasung G-4
All Dimensions are in Millimeter



Isometric View

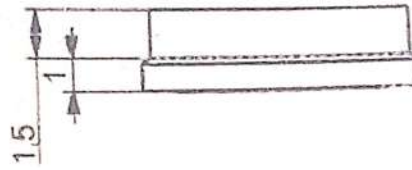

Side View

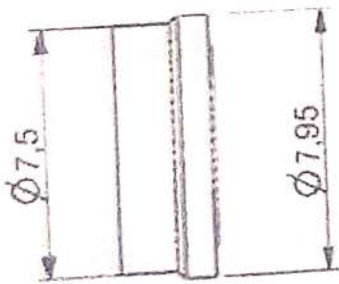

Front View

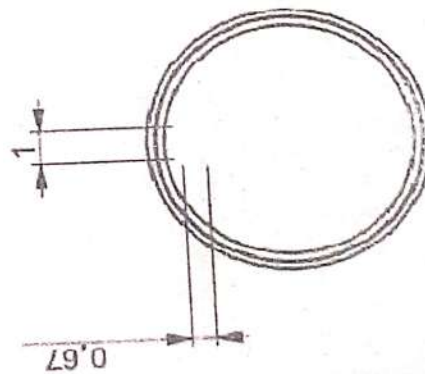

Top View

Technical Bid Evaluation Criteria:

Offers of the bidders will be evaluated strictly in accordance with the above stated technical specifications

Signature
13208-1

Technical Specifications of Dust Cap for BK Meters

Cap Inner Dia = 32.34 mm

Thickness of Cap = 1.25 mm

Length/Depth of Cap = 13.5 mm

Material = Polyethylene

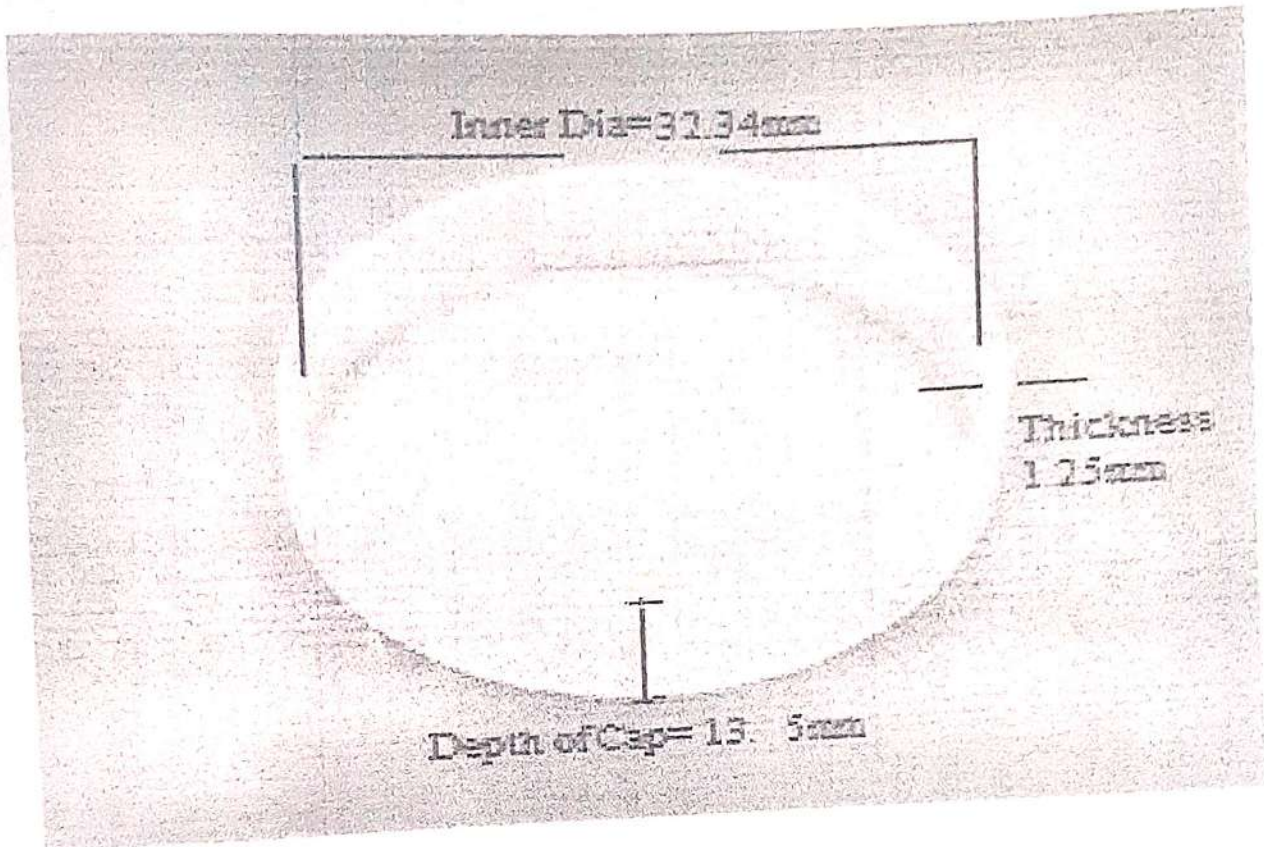

Note:

All bidders shall ensure that bid documents as well dimensions/design should be kept confidential and shall not supply these items other than SNGPL.

Technical Bid Evaluation Criteria:

Offers of the bidders will be evaluated strictly in accordance with the above stated technical specifications

D. D. D. D.
132.08-1
[Signature]

Dust Cap for Domestic Meters

Cap Inner Dia = 28.8mm
Thickness of Cap = 0.8 mm
Length/Depth of Cap = 11.65 mm
Material = Polyethylene

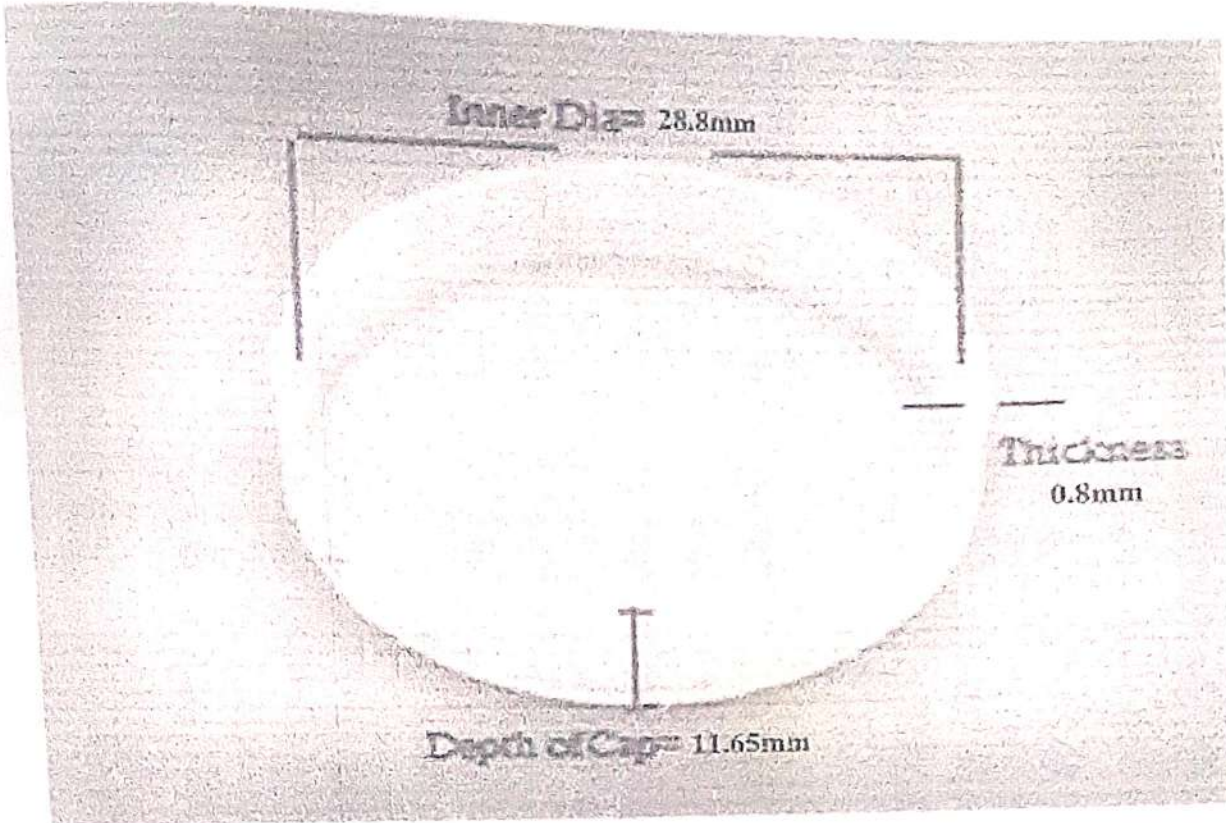

Note:

All bidders shall ensure that bid documents as well dimensions/design should be kept confidential and shall not supply these items other than SNGPL.

D. Baker
13208-1

W

g

Technical Bid Evaluation Criteria:

Offers of the bidders will be evaluated strictly in accordance with the above stated technical specifications

Item # 1- L-KEY SEALING BOLT FOR MKM METER COUNTER, Size: 4*10 (35.017.02203.03.00)

- i. Size: 4*10
- ii. L Key Size: 3mm
- iii. Head Diameter: 7.0 mm
- iv. Head Height: 4.0 mm
- v. Total Length: 14mm
- vi. Thread length: 10mm
- vii. 01 No Cross Drill Hole at head: 1.5mm

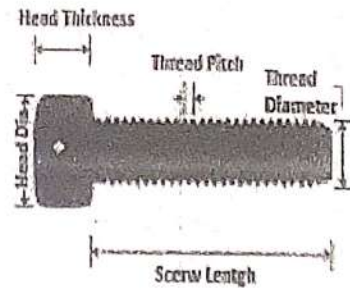

Aliy Abbasi sb

AS/17-05-27

W. ZULFIKAR
Supt. (M) Meter Shop
Central Metering Dept. Govt. of Punjab
Lahore

*04 Nos samples
required
20/*

Technical Bid Evaluation Criteria:

Bidders may please be advised to submit samples with their offers. Offers of the bidders will be evaluated strictly in accordance with the technical specifications and submitted samples. Bidder may please be communicated that they can visit Central Meter Shop to check sample of required item.

GENERAL TERMS

1. LANGUAGE

The ruling language of this tender is English.

2. PRICES

- 2.1 Bidders are required to submit their firm and irrevocable offer in Pak Rupees, which must be based on free delivery at our specified stores /location.
- 2.2 Prices should be quoted on Price Terms Sheet on Appendix “D”. Bid for lesser quantities than specified in the tender shall not be accepted.

3. STANDARDS

- 3.1 Where National/International standards are specified, material meeting other authoritative standards which ensure an equal or higher quality than the standards mentioned will also be acceptable.
- 3.2 Where definitions are given in terms of specific National/International standards those should be taken as a very close approximation of the requirements to be met.
- 3.3 In each case where reference is made to any specific National/International standards, ensuring equal or higher quality will also be acceptable. In case your offer conforms to Standards other than specified in the tender enquiry, you are required to submit along with your bid, one copy each of those standards in English, and evidence that the standards used are recognized and authoritative standards which ensure equal or higher quality. In case you do not submit the required evidence and copy of the standards, then your offer may not be considered.
- 3.4 In case the bidder is not able to fully comply with the technical specifications of tender enquiry, he must indicate his reservations in the offer and submit complete specifications/literature of the items he is offering. Bids will be disqualified if relevant technical literature/specifications are not attached to the offer.

4. CLARIFICATION OF BID

- 4.1 Quotations should not have any over-writings. Corrections if any, must be made by deleting and re-writing. All such deletions/cuttings must be authenticated by additional signatures. Quotations carrying over-writing are likely to be disregarded.
- 4.2 No bidder will be permitted to alter his bid after the bids have been opened, but clarifications not altering the substance of the bid may be solicited and/or accepted. No bidder will be asked or required to alter the substance of his bid.

- 4.3 It is the intention of Sui Northern Gas Pipelines Limited, to deal directly with manufacturers of the items required.
- 4.4 All deviations from or exceptions to, or qualifications of specifications shall be clearly stated separately in the proposals.
- 4.5 The manufacturers should offer only one product against each item, in conformity with the specifications stipulated in the tender documents.

5. REJECTION OF BIDS.

- 5.1 Sui Northern Gas Pipelines Limited reserves the right to reject any or all bids which do not meet the intent of the specifications or where there is evidence of lack of competition or where the lowest bid exceeds the cost estimated by an amount which in the opinion of Sui Northern Gas Pipelines Limited is sufficient to justify such a cause.
- 5.2 The Company does not bind itself to accept the lowest or any particular bid or any part of a bid, nor will be responsible to pay the expenses or losses which may be incurred by any tenderer/ bidder in the preparation of his bid.

6. EVALUATION OF BIDS

- 6.1 For the purposes of determining the lowest evaluated bid, facts other than price such as guaranteed delivery period, reliability and efficiency of material, availability of service and spare parts and creditability of bidders will be taken into consideration.
- 6.2 Every bidder is required to submit only one proposal / option against of one tender documents set. Alternate / second option / proposal can be submitted by procuring new tender documents set with submission of separate bid bond. Submission of more than one options / offers against purchase of one tender document set by submitting one bid bond will lead to disqualification / rejection of the whole bid. No further chance / clarification to withdraw additional offer / option will be provided.
- 6.3 Bids will be evaluated on item-wise basis, unless and until mentioned otherwise. However, in case, after evaluation, the tendered quantities are splitted between two or more bidders and chunk of any supplier(s) is too small to cover administrative cost on further processing of the purchase order, pre-shipment inspection cost etc, as determined by the procuring agency, order of such item(s) will be placed on next lowest available responsive bid winning / securing orderable quantities.

7. CANVASSING

Canvassing by any bidder at any stage of the tender evaluation is strictly prohibited. Any infringement will lead to disqualification.

8. AWARD OF CONTRACT

It is the intention to award a contract to the bidder whose bid has been determined to be the lowest evaluated technically acceptable bid and who meets the approximate standard of capability and financial responsibility subject to our reservation as mentioned at clause 6 above.

9. VALIDITY OF BIDS

- 9.1 Your offer must remain valid for a period of **60 days** from closing date of the tender. Bids received with shorter validity may be considered non-responsive.
- 9.2 The buyer/purchaser may, however, request for extension of validity of bids without any change in quoted price and other terms and conditions. The bidder (s) may refuse to extend validity of their bid beyond their quoted validity.

10. BID SECURITY

- 10.1 Every bidder shall furnish as part of its bid, bid security (in original), in the amount as mentioned in **SOR** (schedule of Requirement) in the form of a Bank Draft / Pay Order or a bond (Bid Bond) issued by a scheduled Bank of Pakistan on a non-judicial stamp paper (as per specimen enclosed as Appendix 'E') valid for **30 days** beyond the validity of bid/ quotation from the date of bid opening or extended validity of bid. This will serve as a guarantee of acceptance of purchase order in case his bid turns out to be the lowest evaluated bid.
- 10.2 Any Bid, which is not accompanied by the requisite bid security (in original), would be treated as without bid security and will not be read out at the time of tender opening and will be considered as non-responsive. No Telefax advice regarding issuance of Bid Bond received from bidder / Bank will be considered sufficient in lieu of actual Bid Bond. Bids received along with bid security in the amount of less than required amount shall be treated as non-responsive.
- 10.3 This bid bond will serve as guarantee in case bidder subsequently either withdraw, or unilaterally modify, vary or alter his bid after opening of the bids and before expiry of bid validity period, or fail to accept our purchase order, placed on them within the validity of their bid or its extended validity in case his bid turns out to be the lowest evaluated bid. Bid Bond will be retained until SNGPL enters into an Agreement or until 90 days after bid opening date, whichever is later.
- 10.4 The cost of the above bonds shall be borne by the Bidder.
- 10.5 The bid security may be forfeited: -
 - a) If any bidder withdraws its bid, during the period of bid validity specified by the bidder in his bid or extended period of validity of their bid/quotation.
 - b) In the case of successful bidder, if the bidder fails: -
 - i) To sign the Contract/Purchase Order or
 - ii) To furnish Performance/Warranty Bond Guarantee.

11. PERFORMANCE/WARRANTY BOND GUARANTEE

- 11.1.1 **PERFORMANCE SECURITY:** (as per draft Appendix- 'F'). **Within 30 days** after the receipt of Purchase Order, the supplier shall furnish Performance/Warranty Bond Guarantee in the form of Bank Guarantee issued by a scheduled Bank in Pakistan, to the purchaser in the amount of **10%** (ten percent) of the total net value of the contract (excluding taxes).

Performance Security may also be provided in shape of **Pay Order/ Bank Draft/CDR favoring SNGPL** along with an undertaking on non-judicial stamp paper for Rs.100/- that “the supplier/bidder accepts tender enquiry/purchase order terms including Performance/warranty bond guarantee, Late delivery charges, termination of contract etc. and shall comply these term & conditions.

- a) The proceeds of the Performance Security shall be payable to the purchaser as compensation, in whole or in part, for supplier’s failure to complete its obligations under the contract, on pro-rata basis to the extent of contract (amount) not performed, in addition to other claims, if any as mention in the tender documents.
- b) This will serve as Performance Bond to guarantee timely and complete delivery of the material as per delivery schedule.

Subsequently, this will serve as Warranty Bond as per clause 11.2 given below: -

11.1.2 The Performance/Warranty Bond Guarantee, if provided within the given time period of **30 days**, shall remain valid for a period of **not less than 6 months**, after the last portion of the goods and / or services have been delivered to the final destination indicated in the contract. In case Performance/Warranty Bond Guarantee is not received within given time period of 30 days, the validity period of **06 months** will be increased to **09 months** after the last portion of the goods and services are delivered to the final destination. In case, the Performance/Warranty Bond Guarantee is not received within 60 days, the relevant clauses of the tender / purchase order will be invoked, contract will be terminated and submitted bid bond will be forfeited.

11.1.3 Pursuant to above, after initial period of **30 days**, a notice will be served to supplier for submission of Performance/Warranty Bond Guarantee within next 10 days. In case of adherence to the notice, the period of Performance/Warranty Bond Guarantee will be as per stipulation of clause 11.1.2. In case the supplier fails to submit Performance/Warranty Bond Guarantee even after 10 days of notice, final notice will be issued to submit Performance/Warranty Bond Guarantee within next 20 days (overall not later than 60 days of receipt of the purchase order). In case of failure, purchase order will be terminated and bid bond will be forfeited.

11.2 WARRANTY

11.2.1 The supplier warrants that the goods and services supplied under the contract shall conform to the specifications provided in this tender enquiry. The supplier also warrants that the good and services supplied under the contract are new, unused, of the most recent improvements in design and material unless provided other-wise in the contract. The supplier further warrants that the goods and services supplied under this contract shall have no defects arising from the design, materials or workmanship (except in-so-far as the design or material is required by the purchaser’s specifications) or from any act of omission of the supplier, that may develop under normal use of the supplied goods in the condition’s usage at final destination.

11.2.2 The purchaser shall promptly notify the supplier in writing of any claim arising under this warranty. Upon receipt of such notice, the supplier shall, with all reasonable speed (but not later than original delivery period), replace the defective goods or parts thereof, without costs to the purchaser.

If the supplier having been notified, fails to replace the defective goods and pay all costs/expenses and damages within a given time period, the purchaser may proceed to take such remedial action as may be necessary, at the supplier's risk and expense and without prejudice to any other rights which the purchaser may have against the supplier under the contract, including partial or complete forfeiture of the Performance/warranty Bond Guarantee.

11.2.3 In case any material has been wrongly / short supplied, found being not in conformity with the specifications provided in the tender enquiry / purchase order, either on account of inferior quality, defective workmanship, faulty design, faulty packing or short received, the supplier apart from the short supplies, faulty or defective material, will undertake to replace the item(s) free of charge and shall also pay all cost/expenses and damages incurred by SNGPL due to breach of warranty including extra duties and taxes paid by SNGPL on account of payment of such duties/taxes for the second/or more time of free placement(s). Full cost of replacement shall mean the cost of locating the failure cutting out, removal of faulty material, supply and insertion of new material, coating & wrapping, hydrostatic test, back filling and commissioning etc. whichever is applicable to such an eventuality.

11.2.4 The defective item(s) will be handed over by SNGPL to the supplier's authorized representative at our site/location.

11.2.5 Supplier's total liability in this respect shall not be limited to the extent of the Performance/Warranty Bond Guarantee.

11.2.6 Nothing contained herein shall be construed to limit the suppliers' obligations and liabilities with regard to the performance of the contract /purchase order.

11.2.7 The Performance/Warranty Bond Guarantee will be discharged by the Purchaser as soon as possible following the date of completion of the supplier's Performance obligations, including any warranty obligations under the contract.

12. LATE DELIVERY AND OTHER CLAIM(S) / CHARGES

12.1 Time shall be essence of the contract/purchase order and it will include a clause on Late Delivery Charges. This interalia will state that if the materials, as given in the order have not been delivered on time and as per stipulations in the contract except on account of Force Majeure, Sui Northern Gas Pipelines Limited (SNGPL) shall be entitled to recover **1%** of the total value (excluding sales tax) of the delayed part of material for each week of delay, by way of Late Delivery Charges subject to a maximum of **10%** of the total value (excluding sales tax) of the delayed part of the material. The period for calculation of Late Delivery Charges shall be reckoned in number of days for which the material was delayed.

- 12.2 All the supplies after expiry of scheduled delivery period will be subject to clause mentioned above and does not require any additional noting / marking / comments on delivery challans etc. at the time of receipt of delayed supplies.
- 12.3 The payment of such Late Delivery Charges shall not relieve the supplier from performing and fulfilling its obligations under the contract nor will the corresponding rights and entitlements of Sui Northern Gas Pipelines Limited be affected or reduced in any manner.
- 12.4 Whenever Late Delivery Charges or any other claim become payable, SNGPL, in its sole discretion shall quantify the same as per tender terms and serve a written notice upon the supplier requiring immediate payment thereof. If the supplier fails to remit payment within the given time period as mentioned in the notice, to be served under any mode of communication i.e. E Mail, Fax, Courier, registered postal cover etc., SNGPL will become entitled to recover the same forthwith by calling upon the complete Performance/warranty Bond Guarantee. The amount over and above the SNGPL's claim
- 12.5 will be returned to the bank, on supplier's account, after completion of contract performance period.

In case of a contract on turnkey basis or the material covered in the contract is a compact unit consisting of more than one item(s) / part(s) or the delayed part of supply / services, in any way, affects the overall completion, utilization or functionality of the whole item / work, the L/D charges will be worked out on whole unit(s).

13. FORCE MAJEURE

- 13.1 Notwithstanding any provision to the contrary contained for damages or be deemed in default of the provisions of the contract/purchase order for failure to perform or delay in the performance of obligations assumed by such party pursuant hereto in-so-far as the said affected party can clearly establish that its performance has been prevented or delayed by Force Majeure. The term "Force Majeure" as employed herein shall mean acts of Government in their sovereign capacity, riots, strikes, lock outs, fire occurring in the supplier's establishment, political disturbances, mobilization, wars, unprecedented flood, storms hurricanes or other acts of God.
- 13.2 If a party wishes to claim relief of by reasons of Force Majeure, it shall within ten days of its occurrence serve written notice of occurrence of such a Force Majeure on the other party through registered posts. The two parties shall consult each other and agree upon the measures to be taken. As soon as the Force Majeure ends, the affected party shall promptly resume performance of its obligations under the agreements and intimate the other party about this.

14. TERMINATION OF CONTRACT

- 14.1 In case a contract/purchase order is placed on the basis of this tender enquiry Sui Northern may, without prejudice to any other remedy for breach of contract, by written notice of default sent to the supplier terminate the contract in whole or in part.

- a. If the supplier fails to deliver any or all of the goods within the time period(s) specified in the Contract/order, or any extension thereof granted by Sui Northern.
 - b. If the supplier fails to perform any other obligation(s) under contract/order or
 - c. If the supplier, in either of the above circumstance, does not cure its failure within a period of **30 days** after receipt of the default notice from Sui Northern.
15. In the event, Sui Northern terminates the contract in whole or in part pursuant to para 14 Sui Northern may procure, upon such terms and in such manner as it deems appropriate goods similar to those undelivered, and the supplier shall be liable to Sui Northern for any excess cost for such contract to the extent not terminated.
16. Your material/goods are liable to be technically/physically inspected by us and if you fail to supply the material/goods according to our specifications, we reserve the right to cancel our purchase order on you.
17. Complete technical literature/relevant brochure of the goods offered should be accompanied with the offer, failing which the bid is liable to rejection. Technical catalogue/literature are necessarily required in support of the quoted specifications. In case the accompanying literature does not support the specifications as quoted in the bid, it would be liable to rejection.
18. In case the supplier fails to supply the goods within stipulated period and seeks extension from the Company and that in the event of extension granted by the Company in completion of the supply of goods, in case the existing tax including excise duty is either increased or new tax is imposed by the government during the extended period delayed delivery by the bidder, payment thereof will be the sole liability of the seller and the Company shall not be liable to pay any such amount to the supplier/seller on account of imposition of new duty custom, excise or tax or increase in existing rate of duty custom, excise or taxes.
19. While tendering your quotation, the present trend in the rate of material/goods in the market should be kept in mind. No request for increase in price due to market fluctuations in the cost of material/goods will be entertained.
20. In case of an order on you, you will be required to execute the order strictly in accordance with the terms and conditions of the order. In case any of the terms and conditions of the order are violated we will have the right to cancel the Purchase Order or part thereof as necessary.

21. POST QUALIFICATION

- 21.1 In the absence of prequalification, the purchaser shall determine to its satisfaction based upon an examination of the documentary evidence of manufacturer's financial, technical and production capabilities submitted by the bidders along with its bid. Pursuant to the following as well as any other information as the purchaser may deem necessary and appropriate: -

- a) That, in the case of bidder offering to supply imported goods under the contract which the bidder did not manufacture or otherwise produce, the bidder has been duly authorized by the goods manufacture or produce to supply the goods in the purchaser's country.
- 21.2 The purchaser shall determine to its satisfaction whether the supplier/manufacturer selected as having submitted the responsive bid is qualified and has the capability and resources to satisfactorily perform the contract.
- 21.3 The bidder will provide the names and addresses with names of contacts including Email Addresses telex/telex numbers of the Companies to whom the tendered product has been sold in size- able quantity during the last five years. Simply submitting a list of customers to whom the manufacturer has been supplying various goods, will not meet the intent and purpose of this requirements. This information must form a part of bid, and the bidders are not encouraged to submit any of this information subsequently after public opening of the bids.

The bidder shall provide documentary evidence of their having been in the line of manufacturing the offered items for the past five (5) years.

- 21.4 However, bidders quoting an item or material of a manufacturer, which has been successfully supplied during last 05 Years to SNGPL w.r.t. brand / model # / make / country of origin / manufacturing, against any of previous purchase order, or has been declared technically responsive after meeting Post Qualification Terms against any of SNGPL tender enquiry during the last 05 years of the tender enquiry date, are exempt from clause 21.3. A proof of eligibility (i.e. copy of SNGPL's purchase order or technical responsive letter) however has to be attached with the bid instead. Without any proof, the bid will be considered deficient to clause 21.3.
- 22 Quotations from bidders, who are determined to have previously in Sui Northern's judgement committed default in respect of any of its obligation against any of our previous contracts on them will not be entertained.
- 23 An affirmative determination will be a pre-requisite for award of the contract to the bidder. A negative determination will result in rejection of the bidder's bid, in which event, the purchaser will proceed to the next lowest evaluated bid to make a similar determination of that bidder's capabilities to perform satisfactorily.
- 24 In case of purchase order on you and subject to above, if the purchase order on you or part thereof is cancelled, we shall have the right to make purchase from other source at your risk and cost and difference if any will be recovered from you.

25. PAYMENT

- 25.1 Payment of your bills will be made by our Accounts Department within 30 days' time after satisfactory completions of the delivery and submission of Bills as given in the purchase order.

25.2 Supplier's bill in duplicate accompanied by a receipted copy of Delivery Challan should be submitted within 30 days of the date of delivery of the material. Any delay in submitting the bills will result in corresponding delay in payment.

OR

25.3 Payment will be made against inland L/C on 30 days deferred payment basis. In such an event, bank charges pertaining to the L/C will be borne by seller/supplier/beneficiary.

25.4 Government taxes as per prevailing rules will be deducted from supplier bills, as required vide Gazette Notification No.15 INCOME TAX) deduction of Tax at source. If you are exempted from deduction of advance tax, you may state so and enclose a photocopy of any such Valid Tax Exemption Certificate.

25.5 In case the local suppliers desire payment through inland Letter of Credit they should so state in their respective bid. In that case, all bank charges relating thereto would be borne by the suppliers.

25.6 In case a supplier who can deliver material 30 days before scheduled delivery, will be paid within 15 days (instead of 30 days as per order). If delivery is made 60 days before schedule, payment will be made within 07 days (instead of 30 days).

25.7 SNGPL as withholding agent, as per Sales Tax Special Procedure (withholding) Rules 2007, shall deduct the amount of sales tax shown in the sales tax invoice issued by the supplier and make payment of the balance amount as per prevailing rules/ laws.

26. DEVIATION IN PAYMENT SCHEDULE

The general conditions of contract indicate the payment schedule offered by the purchaser, if a bid deviates from the schedule and if such deviation is considered acceptable to the purchaser, the bid will be evaluated by calculating interest earned for any earlier payments involved in the terms outlined in the bid as compared to those stipulated in his invitation, at a rate of **14 percent** per annum. In case after adding such interest, a supplier turns out to be the lowest bidder and order is eventually placed on them, payment will be made to them within the period quoted by them and on which interest is worked out as above.

27. ARBITRATION/RESOLUTION OF DISPUTES

27.1 Any difference of dispute arising out of or in connection with the contract between the Purchaser and the Supplier which cannot be amicably resolved shall be referred to **Arbitration in Lahore**, Pakistan, to two Arbitrators, one to be appointed by each party of such difference/dispute. In case of the judgment of the said Arbitrator being at variance, the matter shall be referred to an "Umpire", who shall be appointed by both the said Arbitrators. The Umpire shall be retired judge of a High Court or the Supreme Court of Pakistan. Such Arbitrators and Umpire shall together proceed to adjudicate the dispute in accordance with the Arbitration Act, 1940, as amended from time to time.

- 27.2 Prior to the exercising of any right by the purchaser or supplier to terminate the contract under the conditions stipulated above, a written notice shall be required to be given to the other party specifying such default(s) and calling for submission of an explanation within seven (7) days of receipt of such notice. If such explanation is not furnished within the stipulated time or if so furnished, is found to be unsatisfactory, and the default(s) continues, the contract be terminated with notice to the other party before outerring upon the reference.
- 27.3 The agreement shall be governed by Pakistan Law and the arbitration language shall be English.
- 27.4 During the course of arbitration, the supplier shall not suspend the performance of his responsibilities and obligations under the Contract unless authorized by the purchaser in writing to do so.
28. The supplier or contractor who, in the sole opinion of the Company (SNGPL) committed default is performing part of his obligations under the contract awarded to him by the Company, in addition to other penalties likely to be imposed against him in terms thereof, shall also disentitle him to participate in the tender enquiry of similar goods issued by the Company for at least one year from the determination of such default by the Company on the part of the Supplier or Contractor.

29. INTEGRITY PACT

The bidders are required to read the text of Integrity Pact attached with tender documents (Appendix-H) and confirm their concurrence of execution of the same in case order having value Rs. 10 Million or above is placed on them. This mandatory requirement under PPRA Rules 2004.

In case of placement of Purchase order having value Rs.10 Million or above, the bidders are required to sign Integrity Pact as per specimen attached. Payment to the suppliers will be released only after signing the said integrity pact.

30. Every bidder is required to attach receipt of cost of tender documents with his offer.
31. In case of any Pre-bid query, the Clarification should be sought 07 days prior to the tender opening date.

TENDER ENQUIRY NO. LE _____ /2

1	2	3	4	5	6	7	8	9	10
Sr. #	Description	Quantity	Unit Price Ex-Work (Including Duties & Taxes if any but Excluding Sales Tax) Rs.	Unit Freight & Other expenses for free delivery excluding Sales Tax Rs.	Unit Price Free Delivery without Sales Tax (4+5) Rs.	Total Price Free Delivery without Sales Tax (3x6) Rs.	Sales Tax Rs.	SED Rs.	Total Value Free Delivery Including Sales Tax & SED (7+8+9) Rs.

Note: Bidders must in their quotation write the price(s) quoted by them in figures as well as in words. In case of discrepancy between unit price and total price, the unit price shall prevail.

- Authorized Signatures of Bidder
- Name
- Company Seal
- Date
- Place

Bid Bond No. _____

Date: _____

**M/s Sui Northern Gas Pipelines Limited,
21-Kashmir Road,
Lahore, Pakistan.**

B I D B O N D

As per request of M/s _____
(herein called customer)

is hereby issued of Guarantee No. _____ Dated _____

in favour in the sum of _____
(Amount)

on account of M/s _____ as Bid Bond as

per requirements of your tender enquiry No. _____

due on _____ (or supply of _____).

The surety is being issued to enable the Accountee to participate in the tender as per requirement of the tender.

We, therefore, hereby undertake to make an unconditional payment of _____ to you on your first written call and without recourse to the opener, in case the Accountee subsequently either withdraw, or unilaterally modify, vary or alter their Bid after, opening of the tenders and before expiry period of their bid of fail or provide Performance / Warranty Bond Guarantee within 15 days after receipt of purchase order.

This bid bond shall remain valid and in full force till after 30 days of the expiry of the bid validity or till after 90 days after the Bids opening, whichever is later, after date no claim will be entertained.

Any claim arising out of this Guarantee must be lodged in writing within the validity period of this Bond certifying that the Accountee failed to meet the requirements, which were covered by this Bid Bond.

(Bank Seal)

TENDER ENQUIRY NO. LE-_____ /2

Performance Bond Guarantee No. _____

Date: _____

Amount _____

Valid up to 06 months after the last portion of the goods have been delivered to the final destination indicated in the contract and till _____ which is later.

**M/s Sui Northern Gas Pipelines Limited,
21-Kashmir Road,
Lahore, Pakistan**

PERFORMANCE WARRANTY BOND GUARANTEE

As per request of M/s _____ we hereby issue our letter of Guarantee No. _____ in your favour on account of M/s _____ for a sum not exceeding Rs. _____ (Rupees _____) being 10% of the total material value excluding sales tax of your order No. _____ dated _____ as a Performance Bond Guarantee as per requirement and specifications mentioned in the order under the following terms and conditions: -

1. This guarantee is available for payment, without recourse to the opener, against beneficiary first written call to do so accompanied by a written statement certifying that the opener failed to comply with the terms and conditions of the order.
2. The Guarantee Bond shall terminate six months after the last portion of the goods have been delivered to the final destination indicated in the purchase order and till _____ which is later.

All claim under this guarantee must be submitted to us not than the said validity date after which guarantee become automatically null and void and the bank will stand discharged and released from all its liabilities.

NAME OF BANK

**SD/-
OFFICER (SEAL) MANAGER**

TENDER ENQUIRY NO. LE-_____ /2

**(To be typed on Company's
Letter Head, by the same
Signatory / signatories, who
have signed the bid(s).**

AUTHORITY LETTER

**M/s Sui Northern Gas Pipeline Limited,
21-Kashmir Road,
Lahore**

We M/s _____ representing
M/s _____ are / have submitted quoted
Ref. _____ dated _____ against tender enquiry No.
_____ dated _____ due for opening on _____
at _____ hours.

We hereby authorize Mr. _____
to **(Name)**

attend the public opening of the bids on our behalf. He has been further authorized to authenticate any erased / fluided figure(s) or corrections, if any, in the bid.

SIGNATURE _____
STAMP _____

INTEGRITY PACT

DECLARATION OF FEES, COMMISSION AND BROKERAGE ETC PAYABLE BY THE SUPPLIERS OF GOODS, SERVICES & WORKS IN CONTRACTS WORTH RS. 10.00 MILLION OR MORE

Contract Number: _____ **Dated:** _____

Contract Value: _____

Contract Title: _____

(Name of Supplier) hereby declares that it has not obtained or induced the procurement of any contract, right, interest, privilege or other obligation or benefit from Government of Pakistan or any administrative subdivision or agency thereof or any other entity owned or controlled by it (GoP) through any corrupt business practice.

Without limiting the generality of the foregoing **(Name of Supplier)** represents and warrants that it has fully declared the brokerage, commission, fees etc., paid or payable to anyone and not given or agreed to give and shall not give or agree to give to anyone within or outside Pakistan either directly or indirectly through any natural or juridical person, including its affiliate, agent, associate, broker, consultant, director, promoter, shareholder, sponsor or subsidiary, any commission, gratification, bribe, finder's fee or kickback, whether described as consultation fee or otherwise, with the object of obtaining or inducing the procurement of a contract, right, interest, privilege or other obligation or benefit in whatsoever form from GoP, except that which has been expressly declared pursuant hereto.

(Name of Supplier) certifies that it has made and will make full disclosure of all agreements and arrangements with all persons in respect of or related to the transaction with GoP and has not taken action or will not take any action to circumvent the above declaration, representation or warranty.

(Name of Supplier) accepts full responsibility and strict liability for making any false declaration, not making full disclosure, misrepresenting facts or taking any action likely to defeat the purpose of this declaration representation and warranty. It agrees, that any contract, right, interest, privilege or other obligation or benefit obtained or procured as aforesaid shall, without prejudice to any other right and remedies available to GoP under any law, contract or other instrument, be void able at the option of GoP.

Notwithstanding any rights and remedies exercised by GoP in this regard, **(Name of Supplier)** agrees to indemnify GoP for any loss of damage incurred by it on account of its corrupt business practices and further pay compensation to GoP in an amount equivalent to ten time the sum of any commission gratification, bribe, finder's fee or kickback given by **(Name of Supplier)** as aforesaid for the purpose of obtaining or inducing the procurement of any contract, right, interest, privilege or other obligation or benefit in whatsoever form from GoP.

(Buyer)

(Seller/Supplier)

TENDER ENQUIRY NO. LE - _____ /2

QUESTIONNAIRE/COMMERCIAL TERM SHEET

		<u>Yes</u>	<u>No</u>
1.	Is your offer firm and irrevocable as per terms and conditions of tender enquiry?	<input type="text"/>	<input type="text"/>
2.	Do you agree to the delivery schedule specified in the tender enquiry?	<input type="text"/>	<input type="text"/>
3.	Is your offer valid for a period of at least 60 days?	<input type="text"/>	<input type="text"/>
4.	Have you submitted Bid Bond in line with Terms and conditions of the tender enquiry?	<input type="text"/>	<input type="text"/>
5.	Do you agree to evaluation of each item separately? (Applicable in case of more than one items)	<input type="text"/>	<input type="text"/>
6.	Do you agree to provide Performance /Warranty Bond Guarantee within 30 days of award of contract?	<input type="text"/>	<input type="text"/>
7.	Do you agree to tender clauses pertaining to Late Delivery Charges?	<input type="text"/>	<input type="text"/>
8.	Do you agree to tender clause pertaining to Force Majeure?	<input type="text"/>	<input type="text"/>
9.	Do you agree to tender clause pertaining to Termination of Contract?	<input type="text"/>	
10.	Do you agree to tender clauses regarding payment?	<input type="text"/>	<input type="text"/>
11.	Do you require payment through L/C or against bills as per option given in the tender enquiry? Please specify.	<input type="text"/>	
12.	Do you have any reservation to any of terms & conditions stipulated in the tender documents Please specify if any?	<input type="text"/>	
13.	Have you enclosed cost break-up of the quoted prices as required in the tender enquiry?	<input type="text"/>	<input type="text"/>
14.	Do you agree to execute Integrity Pact in compliance with PPRA Rules, 2004 (Appendix-H)	<input type="text"/>	<input type="text"/>
The following information must be submitted by the bidders' along with the bid.			
i)	Name of the bidder.	<input type="text"/>	<input type="text"/>
ii)	Type of ownership i.e. Proprietor / Partnership / Private Limited Company / Public Limited Company.	<input type="text"/>	<input type="text"/>
15.	Following relevant paper must be provided in respective cases: -		
i)	Copy of NIC in case of single proprietor.	<input type="text"/>	<input type="text"/>
ii)	Copy of partnership deed in case of partnership.	<input type="text"/>	<input type="text"/>
iii)	Copy of Article of Association for Private / Public Limited Companies.	<input type="text"/>	<input type="text"/>
16.	Date of establishment of business concern.	<input type="text"/>	<input type="text"/>
17.	GST Number along with copy of certificate.	<input type="text"/>	<input type="text"/>
18.	National Tax Number along with copy of Certificate.	<input type="text"/>	<input type="text"/>
19.	Valid Professional Tax Clearance Certificate.	<input type="text"/>	<input type="text"/>

Authorized Signatories of the Bidders

Name: _____ Date: _____

Company Seal: _____ Place: _____

Note: Bidders should write 'Yes' or 'No' (in words) in the above columns.

TENDER ENQUIRY NO. LE-_____ /2

[Stamp Paper]

CERTIFICATE OF FULL DISCLOSURE AND NON-COLLUSION

We, _____, a company/firm registered under the laws of Pakistan and having registered office at _____ hereby declare, confirm and as follows:

1. We have neither offered, given, received or solicited anything of value to influence the actions of any and all parties involved in the procurement process nor misrepresented or concealed any facts in order to influence the procurement process or accomplish the award of contract; nor have we been part of any corrupt or collusive practices prior to or after bid submission which might restrict, reduce or prevent free and open competition, and fair and transparent award of contract.
2. We neither had at the time of submitting the bid nor presently have any relationship, association or link with another bidder nor have we been involved in any arrangement or understanding that directly or indirectly restricted, reduced or prevented free and open competition or a fair and transparent award of contract; and we have made all the disclosures that may be necessary in this regard and nothing has been withheld or concealed from SNGPL.
3. At any stage of the procurement process or after award of the contract, SNGPL may, having evidence of any misrepresentation, inaccuracy, inconsistency or non-conformity in the disclosures, data or other information provided by us, withdraw the letter of award or terminate the contract at our sole cost and expense, and without any liability on the part of SNGPL.
4. This certificate shall form integral part of the contract documents and we shall remain bound by it at all material times.

(DEPONENT)

Verification:

Verified on oath that the contents of this Certificate are true to the best of our understanding, knowledge and belief and nothing has been concealed or misstated herein above.

(DEPONENT)

Dated: the _____

MANNER AND MECHANISM TO BLACKLISTING/ CROSS DEBARRING OF SUPPLIER OR CONTRACTOR

As per PPRA Rule No. 19, following is mechanism to blacklist supplier/ contractor: -

Proceedings for blacklisting: -

- a) General Manager (Procurement) on his own accord or on receipt of information or a complaint shall, after examining the material placed before him shall determine whether it is necessary and appropriate to initiate formal black listing proceedings.
- b) In case General Manager (Procurement) decides to initiate blacklisting proceedings, the case shall be forwarded to the committee duly approved by management from time to time for initiating blacklisting proceedings.
- c) The bidder/ supplier shall be formally intimated in writing by the committee about the nature of complaint/ matter/ default/ fraudulent & corrupt practices as defined in PPRA Rule and initiate the blacklisting/ cross debar proceedings.
- d) The bidder/supplier shall be intimated by giving a fifteen (15) days' notice through courier services, registered post or fax or email and, shall be provided an opportunity of furnishing detailed response either through written representation or personal hearing or both.
If blacklisting proceedings are to be initiated due to supplier's failure to meet the contractual obligations, then the bidder/ supplier shall be given a chance to invoke Arbitration before start of formal blacklisting proceedings.
In case, the supplier/ bidder does not opt for Arbitration within time given, then, notice for blacklisting shall be served accordingly to initiate the proceedings.
- e) In case the bidder/supplier fails to furnish his defense / representation within 15 days of 1st notice of blacklisting, a reminder shall be sent giving another opportunity to furnish the reply within 7 days.
- f) If the bidder/ supplier fails to submit his reply even after 2nd notice or fails to furnish the tenable justification of charges framed against him, the committee may proceed further in this regard on the basis of information, record and material available before him.
- g) The committee shall complete its proceedings within 30 days from the date of first notice given pursuant to paragraph (c) above.

Findings & Decisions:

- a) The Committee after finalizing his proceedings shall record his findings in writing and decide one of the following measures and GM (Procurement) shall obtain approval of the management for implementation:
 - i. Blacklisting and henceforth cross debarred for participation in any public procurement for the period up to **10 years** if corrupt and fraudulent practices as defined in PPRA Rule has been established;
 - ii. Blacklisting and henceforth cross debarred for participation in respective category of public procurement if the bidder/ supplier fails to perform his contractual obligations as per terms of the tender enquiry/ contract and within the specified time. Such blacklisting period shall not be more than **3 years** or,

TENDER ENQUIRY NO. LE-_____/2

- iii. Blacklisting and henceforth cross debarred for participation in respective category of public procurement for a period up to **6 months** if bidder/ supplier alters his bid/ withdraws his bid/ does not accept the contract or does not abide with bid security declaration.

- b) General Manager (Procurement) shall communicate in writing to the PPRA and respective bidder/supplier his decision containing grounds for such action of blacklisting.

Appeal: -

The bidder/ supplier may file appeal against the decision of the committee before PPRA as per conditions/ mechanism defined in PPRA Rules.

PRICE REASONABILITY CERTIFICATE

Please note that the following Price Reasonability Certificate must be submitted along with your quotation.

"Certified that the prices quoted against Tender Enquiry # LE-_____/2 are not more than the prices charged from any other purchase organization and in case of any discrepancy the tenderer / bidder hereby undertakes to refund the price charged in excess."